

20 30 40 50

TPS100 Series



User Manual TC(R)110

English

Version 1.0

Leica
Geosystems

Congratulations on your purchase of a new Leica Geosystems Total Station.



This manual contains important safety directions (*refer to section "Safety directions"*) as well as instructions for setting up the instrument and operating it. Please read this User Manual carefully to achieve maximum efficiency from your instrument.

Product Identification

The type and the serial number of your instrument are indicated on the label inside the battery compartment.

Write the type and serial number of your instrument in the space provided below, and always quote this **information** when you need to contact your **agency** or **service workshop**.

Type: _____ Serial no.: _____

Symbols Used in this Manual

The symbols used in this User Manual have the following meanings:



DANGER:

Indicates an imminently hazardous situation which, if not avoided, will result in death or serious injury.



WARNING:

Indicates a potentially hazardous situation or an unintended use which, if not avoided, could result in death or serious injury.



CAUTION:

Indicates a potentially hazardous situation or an unintended use which, if not avoided, may result in minor or moderate injury and / or appreciable material, financial and environmental damage.



Important paragraphs which must be adhered to in practice as they enable the product to be used in a technically correct and efficient manner.

Contents - Overview

Introduction	9
Operating concept, Keyboard	13
Measuring preparation	21
Measuring	32
Menu	38
Checking and Adjusting	49
Safety Directions	60
Care and Storage	80
Messages and Warnings	83
Accessories	86
Technical Data	87
Index	92

Contents

Area of Applicability	8	Accurate Levelling-Up with Electronic Level	29
Introduction	9	Laser Intensity	30
Special Features	9	Hints for Positioning	30
Important Components	10	Centring with Shifting Tribrach	31
Technical Terms and Abbreviations	11	Measuring	32
Operating concept, Keyboard	13	Displayed Data	32
Focus, Buttons	15	Distance measurement	33
Symbols	16	Coordinate measurement	34
Menu tree	17	EDM Change (TCR only)	35
User Entries	19	Laserpointer (TCR only)	35
Measuring preparation	21	Angle measurement	36
Unpacking	21	Set Hz-angle	36
Batteries	22	Set Hz-angle direction	36
Battery Charger	23	V-angle setting	37
Battery Charger GKL111	23	Menu	38
Inserting / Replacing Battery	25	Settings	38
Setting Up the Tripod	27	System Settings	39
Centring with Laser Plummet,		EDM Settings	42
Coarse Level-Up	28	Angle Settings	44
		Unit Settings	45
		System Information	46

Contents, continued

Checking and Adjusting	49	Electromagnetic Compatibility (EMC)	76
Electronically	49	FCC Statement (Applicable in U.S.)	78
Line-Of-Sight Error (Hz-Collim.)	49	Care and Storage	80
Vertical Index Error (V-Index)	50	Transport	80
Determining Instrument Errors	50	In the Field	80
Determining The Line-Of-Sight Error (c)	52	Inside Vehicle	81
Determining V-Index	53	Shipping	81
Mechanical	55	Storage	81
Tripod	55	Cleaning	82
Circular Level	55	Messages and Warnings	83
Circular Level on the Tribrach	55	Accessories	86
Laser Plummet	56	Technical Data	87
Reflectorless EDM	57	Index	92
Safety Directions	60		
Intended Use of Instrument	60		
Permitted Uses	60		
Adverse Uses	60		
Limits of Use	61		
Responsibilities	62		
Laser Classification	69		
Integrated EDM (Infrared Laser)	69		
Integrated EDM (Visible Laser)	71		
Laser Plummet	73		

Area of Applicability

This User Manual is valid for all instruments in the TPS100 Series.

TC Instruments are equipped with an invisible infrared EDM. The TCR Instruments are also equipped with a visible red laser for reflectorless measuring.

Sections only valid for TCR instruments are marked accordingly.

Introduction

The Leica Geosystems TC(R)110 is a high-quality electronic total station designed for the construction site. Its innovative technology makes the daily surveying jobs easier.

The instrument is ideally suited for simple construction surveys.

The operation of the instrument's functions can be learned easily in a short space of time.

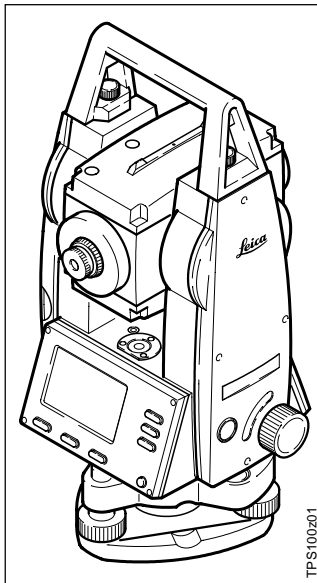

Special Features

- Easy and quickly to learn !
- Interactive keys; with large and clear LCD.
- Small, light-weight and easy-to-use.
- Measurements without reflector with the integrated visible laser beam (TCR instruments).
- Continuous drives for horizontal and vertical angles (tangent screws).
- Laser plummet and electronic level for quick and easy set up.
- Variable battery concept.

Important Components

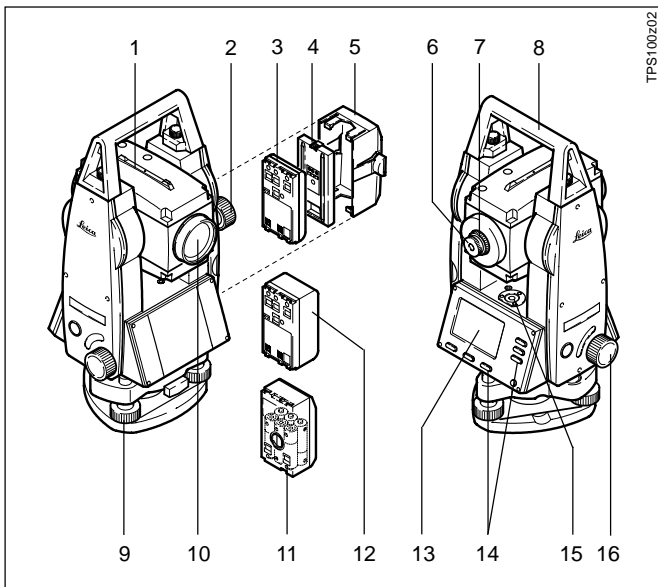

- 1 Alignment sight
- 2 Vertical drive
- 3 Battery GEB111
- 4 Battery spacer for GEB111
- 5 Battery holder for GEB111/
GEB121/GAD39
- 6 Eyepiece
- 7 Telescope focusing ring
- 8 Detachable carrying handle
with mounting screws
- 9 Foot screws
- 10 Objective with integrated
Electro-optic Distance
Meter (EDM)
- 11 Battery adapter GAD39 for
6 single cells (optional)
- 12 Battery GEB121 (optional)
- 13 Display
- 14 Keypad
- 15 Circular level
- 16 Horizontal drive

Technical Terms and Abbreviations

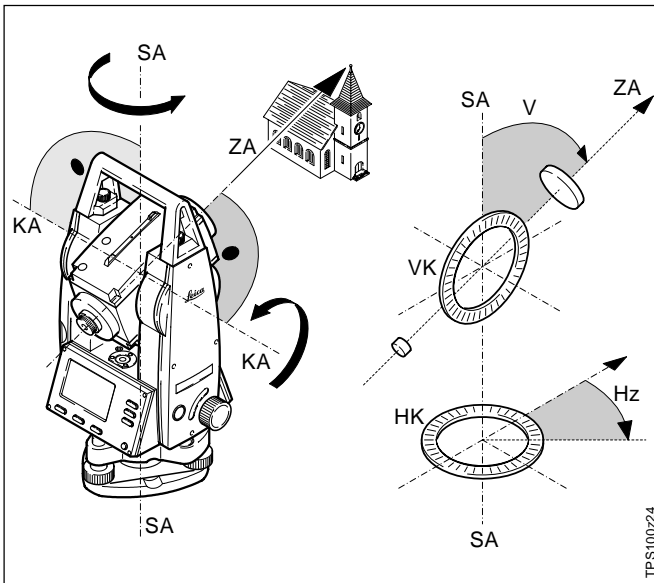

ZA = Line of sight / collimation axis

Telescope axis = line from the reticle to the centre of the objective.

SA = Standing axis

Vertical rotation axis of the total station.

KA = Tilting axis

Horizontal rotation axis of the telescope (Trunion axis).

V = Vertical angle / zenith angle

VK = Vertical circle

With graduated scale for reading the V-angle.

Hz = Horizontal angle

HK = Horizontal circle

With graduated scale for reading the Hz-angle.

Technical Terms and Abbreviations, continued

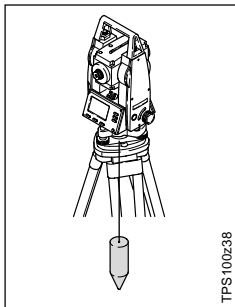

Plumb line / Compensator

Direction of gravity. The compensator defines the plumb line within the instrument.

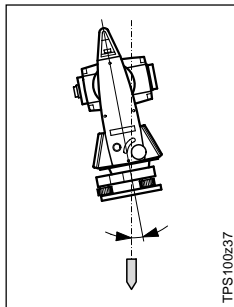

Standing axis Inclination

Angle between plumb line and standing axis.

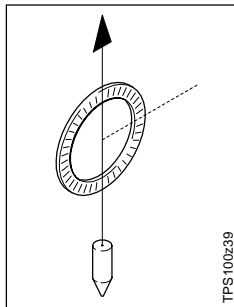

Zenith

Point on the plumb line above the observer.

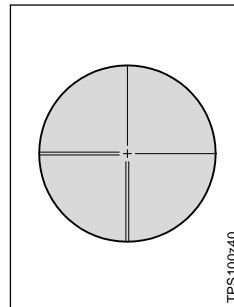

Reticle

Glass plate within the telescope engraved with the cross hair lines.

Operating concept, Keyboard

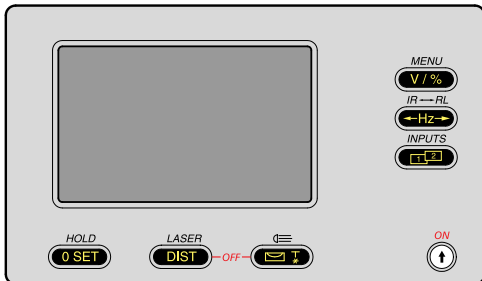

Function keys

Display dependent keys: Used either as fixed keys or as buttons.

- 0 SET** Sets Hz-angle to 0
- DIST** Measures distance and angles
- Envelope icon** Switches electronic level and laser plummet ON/OFF

Fixed keys

- V / %** Sets the "0"-orientation of the V-angle
- ← Hz →** Sets Hz-angle direction
- Scroll icon** Changes display (scroll)

ON/OFF keys







Switches instrument ON













Switches instrument OFF by pressing both keys simultaneously

Operating concept, Keyboard, continued

-  Shift key: Switches to the second key level (**HOLD**, **LASER**, , **MENU**, **IR↔RL**, **INPUTS**).
- MENU**  +  Calls to the menu functions (Instrument settings, System information and calibration)

Key combinations

- HOLD**  +  Holds Hz-angle
- LASER**  +  Switches visible laser beam ON/OFF (TCR only).
-   +  Switches the display illumination ON/OFF and activates the display heating (if the instrument temperature is less than -5°C).
- IR↔RL**  +  Change between the two EDM types IR (infrared) and RL (reflectorless). (TCR only)
- INPUTS**  +  Calls the inputs display for reflector and instrument height)

Focus, Buttons

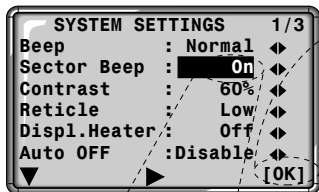

The **focus** indicates the currently processed field. The focus is controlled with buttons.

[OK]

Buttons are functions in the bottom line of the display. A button is always assigned to a function key directly below it ([**0 SET**], [**DIST**], [**✉ T**]).

Important buttons

▼ Moves the focus downwards. Reaching the bottom field the focus jumps to the top field (wrap around).

▶ Selects a setting or starts the edit mode (if the field allows user entries). Refer to chapter "User Entries"

[OK] Confirms settings; starts menu command

[EXIT] Leaves the display

[MEAS] Button for angle measurements in the calibration



Buttons and the focus can be found in the menu and the inputs display. Find more and detailed information about buttons and focus in the relevant sections.

Symbols

1/3, 2/3, 3/3

1/2, 2/2

Indicates that several pages are available which can be selected with . The last page is followed by the first.

.. /.. Current page / total number of pages

I, II Indicates telescope face I or II

 Indicates that Hz is set to "left side angle measurement" (anti-clockwise).

Compensator status



Compensator switched on (2 axes).



Compensator switched off.

Status symbol "EDM type"



Infrared EDM (invisible) for measuring with prisms and reflective targets.



Reflectorless EDM (visible) for measuring without prisms.

Status Symbol "Shift"



was pressed.

Status symbol "Battery capacity"



The battery symbol indicates the level of the remaining battery capacity (75% full shown in the example).



A double arrow indicates choice fields. The desired parameter can be selected using the ► button. Selection fields can be left with the ▼ button.

Menu tree

MENU ( )

[OK] **SYSTEM**

- ▶ Beep
- ▶ Sector Beep
- ▶ Contrast
- ▶ Reticle
- ▶ Displ.Heater
- ▶ Auto OFF

SYSTEM SETTINGS

- Set beep (Off/Normal/Loud)
- Set sector beep (Off/On)
- Set display contrast (0%-100%)
- Reticle illumination (Low/Medium/High)
- Display heater (On/Off)
- Auto OFF (Enable/Disable/Sleep)

 **EDM**

- ▶ Laserpointer
- ▶ EDM Mode
- ▶ Prism Type
- ▶ Prism Const.

EDM SETTINGS

- Visible laser beam On/Off
- Select EDM mode (IR-Standard/IR-Track/IR-Tape/RL-Standard/RL-Track)
- Select prism type (Mini/Round/Tape/RL/User)
- Entry of user specific prism constant (User)

 **ANGLE / UNITS**

- ▶ Tilt Corr.
- ▶ Hz-Collim.
- ▶ Angle Res.
- ▶ Angle
- ▶ Distance

ANGLE / UNIT SETTINGS

- Tilt compensation On/Off
- Hz-collimation (line of sight error) On/Off
- Select angle resolution
- Select angle unit ($^{\circ}$ ' " / gon / 360° decimal / mil)
- Select distance unit (meter / US feet / INT feet / US feet-inch-1/8 inch)

Menu tree, continued

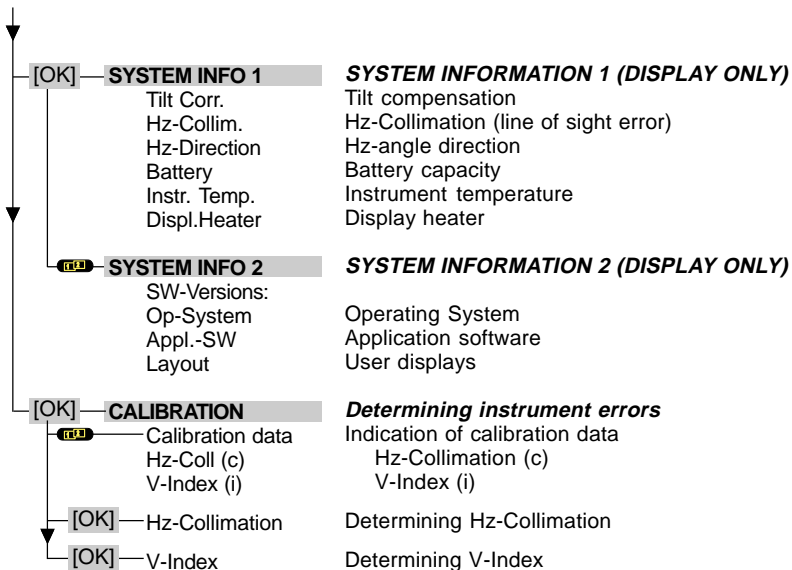

User Entries

User entry fields are characterized by the focus.

- Input fields: Enter/Edit data (e.g. reflector height)
- Choice fields: Selection out of a predefined choice list (e.g. units). A double arrow ◀▶ indicates a choice field.

Character set

The vertical character bar contains the following characters:

- " + " (ASCII 43)
- " - " (ASCII 45)
- " 0 - 9 " (ASCII 48 - 57)

Input fields

Example: Inputs display

INPUTS (↑ + [12])

Opens the Inputs display

- ▼ 1. Position focus on desired input field.
- ▶ 2. Start Edit mode: The vertical character bar is positioned left justified.

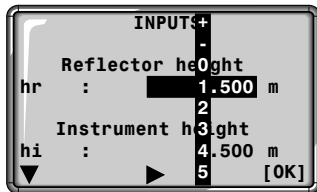

- ▼ 3. Select the desired character.
- ▶ 4. Confirm selected character: The vertical character bar moves to right.
- 5. Repeat steps 3 and 4 if necessary.
- [OK] 6. Confirm input: The vertical character bar is being closed, the focus positions on the next input field.
- [OK] 7. Leaves the display.

User Entries, continued

Choice fields

Example: System settings

MENU ( + )

Opens the MENU display

[OK] Selects the configuration

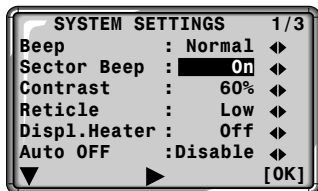

Change display

- ▼ 1. Position focus on desired choice field.
- ▶ 2. Select setting.
- ▼ 3. Confirm setting: The focus positions on the next choice field.
- [OK] 4. Leaves the display.

Measuring preparation

Unpacking

Remove TC(R)110 from transport case and check for completeness:

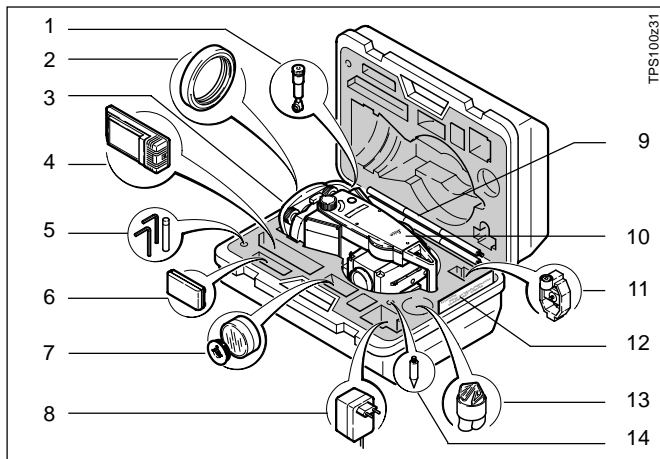

- 1 Diagonal eyepiece or eyepiece for steep angles (optional)
- 2 Counterweight for eyepiece for steep angles (optional)
- 3 Removable tribrach GDF101 / shiftable tribrach GUS75
- 4 Battery charger and accessories
- 5 Allen key (2x)
Adjusting pins (2x)
- 6 Spare battery GEB111
- 7 Sun filter / plug adaptor tribrach (optional)
- 8 Mains adapter for battery charger
- 9 Mini prism rod
- 10 Total station (incl. battery)
- 11 Mini prism + holder
- 12 User Manual / Short Instructions / Mini target plate (only for TCR instruments)
- 13 Protective cover / Lens hood
- 14 Tip for mini prism

Batteries

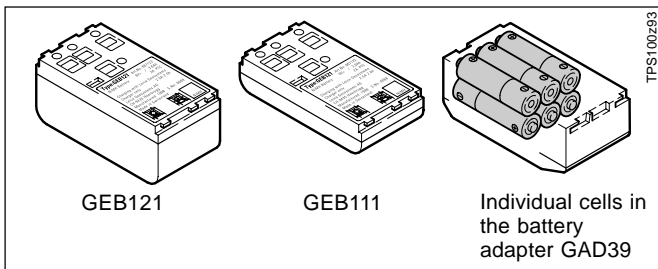

Your Leica Geosystems instrument is operated with rechargeable plug-in batteries. The Basic battery (GEB111) or the Pro battery (GEB121) is recommended for TPS100 Series instruments. As an option, six individual cells can be used with the appropriate battery adapter GAD39.

Six individual cells (1.5 V each) produce a voltage of 9 Volts. The battery indicator in the display is designed for a voltage of 6 Volts (GEB111/GEB121). For this reason the charge state of individual cells is not indicated correctly. The battery adapter with individual cells should therefore be used as a backup.

The advantage of individual cells is the low self-discharge rate - even over longer periods of time.



Only use batteries, battery chargers and accessories recommended by Leica Geosystems.

Battery Charger

The battery charger GKL111 is used to charge the batteries. Please refer to the battery charger user manual for more information.



In order to fully extend battery capacity it is absolutely necessary to carry out 3 to 5 complete charging/discharging cycles with the new GEB111/GEB121 batteries.

Battery Charger GKL111

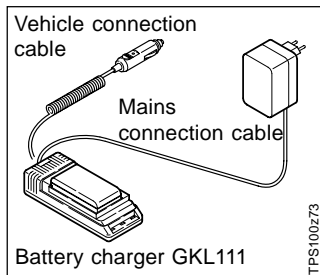

Using the Basic battery charger GKL111 one Basic / Pro battery can be charged. Charging can be carried out via a mains socket using the power supply unit or via the vehicle connection cable inside vehicles (12V or 24V).

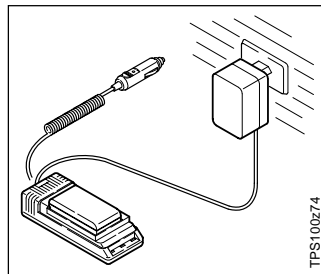

Connect battery charger GKL111 to mains or inside the vehicle. Insert battery GEB111/GEB121 into the charger so that the metal contacts of the charger and of the battery connect and the battery is locked in place. The continuously lit green lamp indicates the charging process.

Battery Charger GKL111, continued

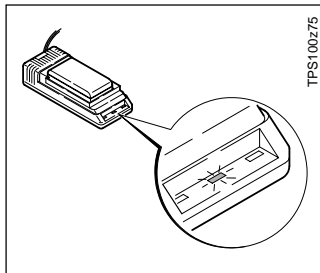

As soon as the green lamp is flashing the battery is charged and can be removed from the charger. Charging time is 1 to 2 hours.

Insert charged battery into the battery holder of your instrument. Pay attention to the correct polarity (corresponding to the diagram in the battery cover).

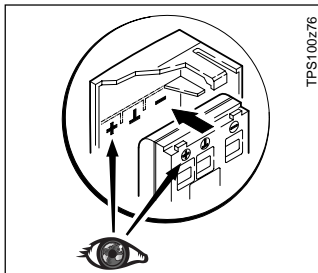

Slide battery holder with inserted battery into the instrument.

Now the instrument is ready for measuring and can be switched on.

Find more information in section *"Inserting / Replacing Battery"* or the instruction leaflet for the charger GKL111.

Inserting / Replacing Battery

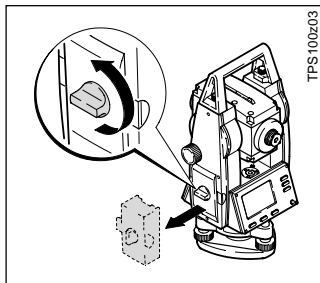

1. Remove battery holder.

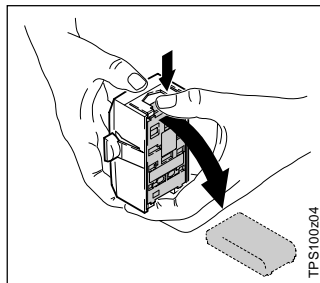

2. Remove battery and replace.

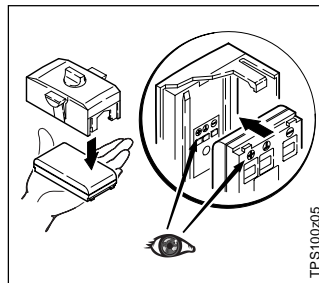

3. Insert battery into battery holder.

Inserting / Replacing Battery, continued

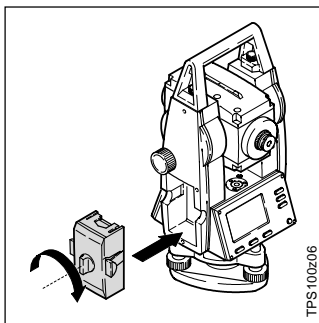

4. Insert battery holder into instrument.

 Insert battery correctly (note pole markings on the inside of the battery cover). Check and insert battery holder true to side into the housing.

- For type of battery see section "Technical Data".

 If the battery GEB121 or the battery adapter GAD39 for six individual cells is used, the spacer for the GEB111 must be removed from the battery holder prior to inserting the battery.

Setting Up the Tripod

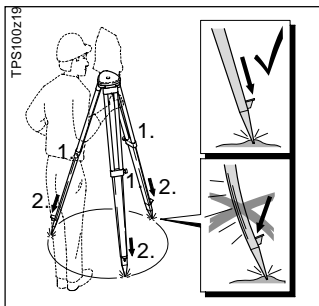

1. Loosen the clamping screws on the tripod legs, pull out to the required length and tighten the screws.
2. In order to guarantee a firm foothold sufficiently press the tripod legs into the ground.

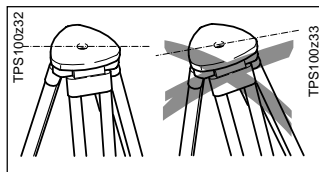

When setting up the tripod pay attention to a horizontal position of the tripod plate.

Heavy inclinations of the tripod plate must be corrected with the tribrach footscrews.

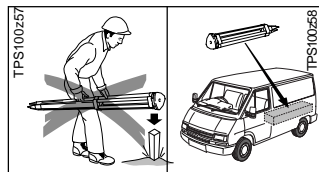

Careful handling of tripod

- Check all screws and bolts for correct fit.
- During transport always use the cover supplied.
- Use the tripod only for surveying tasks.

Centring with Laser Plummet, Coarse Level-Up

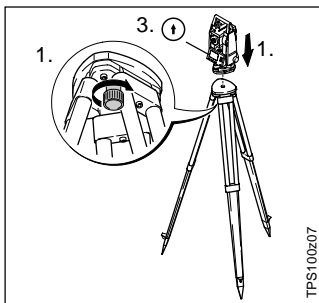

1. Place the instrument onto the tripod head.
Tighten central fixing screw of tripod slightly.
2. Turn footscrews of tribrach into its centre position.
3. Switch on the instrument with .

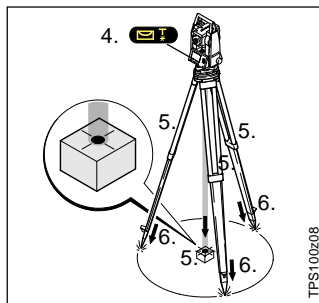

4. Switch on laser plummet with . The electronic level appears in the display.
5. Position tripod legs so that the laser beam is aimed to the ground point.
6. Firmly press in tripod legs.

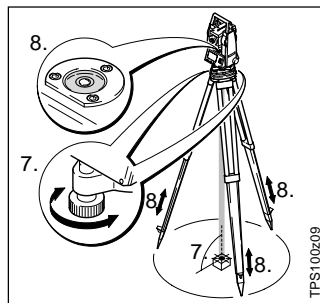

7. Turn the footscrews of the tribrach to centre the laser beam exactly over the ground point.
8. Move the tripod legs to centre the circular level. The instrument is now roughly levelled-up.

Accurate Levelling-Up with Electronic Level

1. Switch on electronic level with . In the case of insufficient levelling-up an inclined level symbol appears.

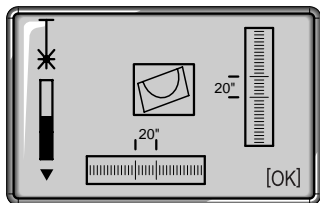

2. Centre the electronic level by turning the footscrews.

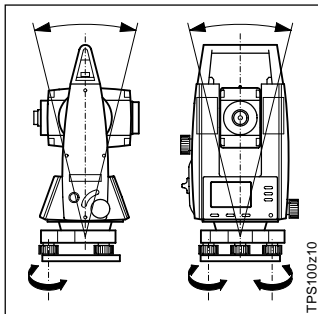

If the electronic level is centered the instrument is levelled-up.

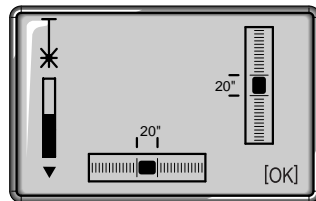

3. Check centring with the laser plummet and re-centre if necessary.
4. Switch off the electronic level and the laser plummet with [OK].

Laser Intensity

Changing the laser intensity

External influences and the surface conditions may require the adjustment of the intensity of the laser. The intensity of the laser plummet can be adjusted in 25% steps as required.

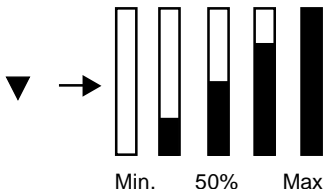

The indicated laser intensity is set, and the function terminated, with the [OK] button .



Laser plummet and electronic level are activated together with



Hints for Positioning

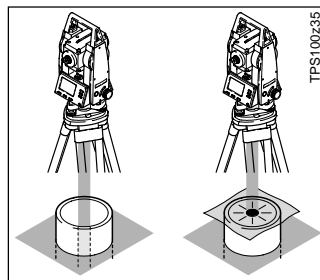

Positioning over pipes or depressions

In some circumstances, the laser spot is not visible (e.g. over pipes). In this case, the laser spot can be made visible by placing a sheet of transparent material over the end of the pipe.

Centring with Shifting Tribrach

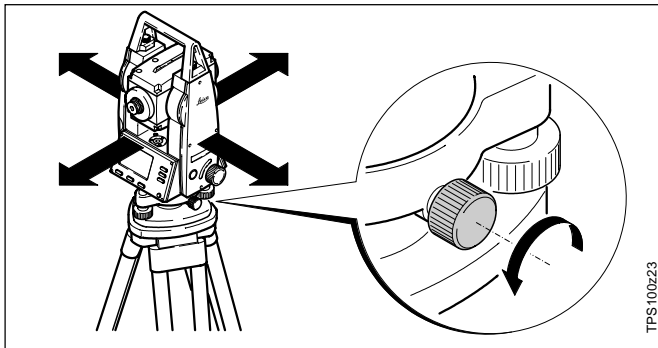

If the instrument is equipped with a shifting tribrach it can be aligned to the ground point by slight shifting.

1. Loosen screw.
2. Shift instrument.
3. Fix instrument by turning screw.

Measuring

After switching on (↑) and setting up correctly, (refer to chapter "Measuring preparation") the total station is immediately ready for measuring.

Example of a possible measuring display:

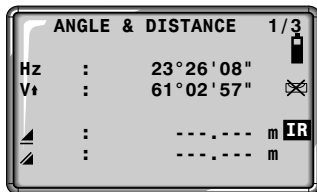

Changes to displays with additional data.

Displayed Data



In measuring mode all keys are active.

Explanation of displayed data

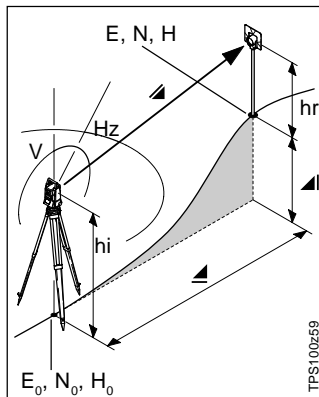

- Hz Horizontal angle
- V Vertical angle
- ▲ Slope distance
- ▲ Horizontal distance
- ▲ Height difference
- E Easting of target point
- N Northing of target point
- H Height of target point
- hr Reflector height above ground
- hi Instrument height above ground
- E0 Station coordinate (Easting)
- N0 Station coordinate (Northing)
- H0 Station height

Distance measurement

Pointing

Centre cross hairs of the telescope to the middle of the prism.

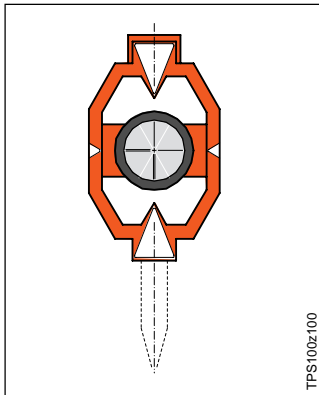

Distance measurement

DIST Triggers a distance measurement and shows this on the display. The displayed distance remains valid until it is replaced by a new distance measurement.

Angles are displayed independently of the distance measurement.

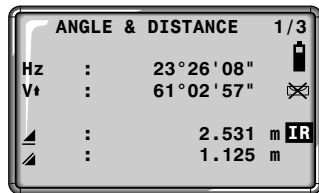

Tracking mode

If the tracking mode is active (refer to chapter "EDM Settings") the distance is triggered continuously after

DIST .

DIST

Stops the tracking mode.

Changes to displays with additional data (e.g. Height difference or Coordinates)



Coordinate measurement

COORDINATES		3/3
hr	:	1.500 m
E	:	23.222 m
N	:	31.962 m
H	:	6.057 m

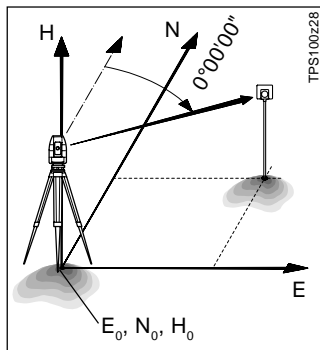
The coordinates of the target point (E, N) always refer to the instrument station as origin of the coordinate system. The northing is defined through the 0° horizontal angle, the easting through the 90° horizontal angle.



EDM Change (TCR only)

IR↔RL ( + )

Change between the two EDM types IR (Infrared) and RL (Reflectorless) as listed below. New setting is displayed for about one second and then set.

IR↔RL	
IR-Standard	RL-Standard
IR-Track	RL-Track
IR-Tape	RL-Standard

- IR: Infrared: invisible, Distance measurements with prisms and tapes.
- RL: Visible laser: Distance measurements without prisms up to 80m.

Find more information in section "EDM Settings".

Laserpointer (TCR only)

LASER ( + )

Switches on or off the visible laser beam for illuminating the target point. The new setting is displayed for approx. one second and then set.

Angle measurement

Set Hz-angle to 0°00'00"

0 SET

1. Aim on orientation point.
2. The following confirmation message is shown:

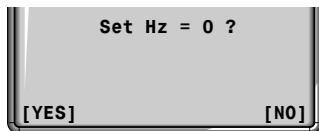

- [YES] 3a: Set Hz-angle to 0. Back to measuring mode automatically.
- [NO] 3b: Back to measuring mode automatically without change.

Set Hz-angle

Set any Hz-angle

HOLD

1. Turn telescope to the desired Hz-angle.
2. Hold indicated Hz-angle. The Hz-angle in the display starts flashing.

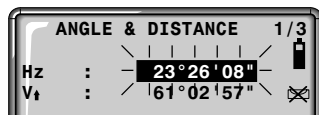

HOLD

3. Aim on orientation point.
4. **0 SET**
5. Set Hz-angle. The Hz-angle stops flashing.

Set Hz-angle direction

← Hz → Switch between "Right angle measurement" (= clockwise) and "Left angle measurement" (= anticlockwise).

 Indicates that Hz is set to "left angle measurement" (anticlockwise).

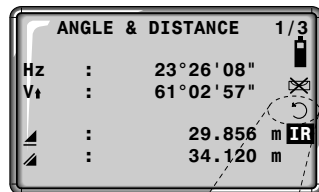

V-angle setting

V/% Sets the "0"-orientation of the V-angle

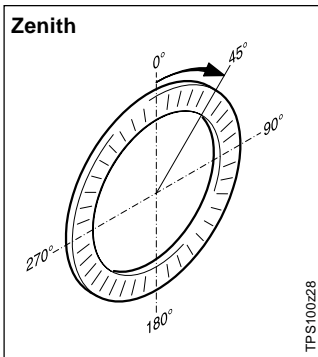

The V-angle increases from 0° - 360° (0 - 400 gon).

↑ is shown on the right of the V-angle

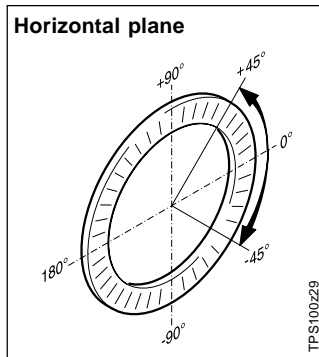

V-angles above the horizontal plane are indicated as positive values and below the horizontal plane as negative values.

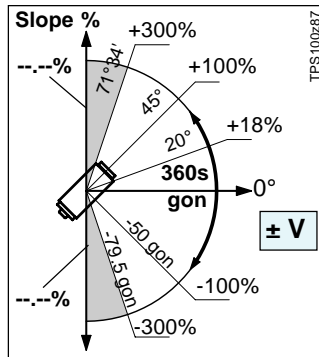

➔ is shown on the right of the V-angle



100% correspond to an angle of 45° (50 gon, 800 mil).

The % value increases rapidly. "---%" appears on the display above 300%.

Menu

MENU ( + )

Opens the menu functions.

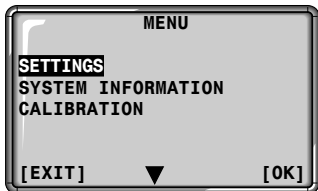

- [EXIT] Leaves the menu.
Back to measuring mode.
- ▼ Selects the desired menu command.
- [OK] Starts the menu command.



The display contents, particularly lines, contained in this description can vary in local versions of the software.

The function of the display is however identical.

Settings

This menu allows user specific settings in order to adapt the instrument to their own requirements.

The settings are subdivided thematically into three displays:

- System settings
- EDM settings
- Angle / Units



 1. Opens the menu functions.

[OK] 2. Starts the "SETTINGS"



3. Changes display

Settings, continued

System Settings

All parameter section fields are available to the user.

- ▼ 1. Position focus on desired choice field.
- ▶ 2. Select setting.
- ▼ 3. Confirm setting: The focus positions on the next choice field.
- [OK] 4. Leaves the display. Back to measuring mode.

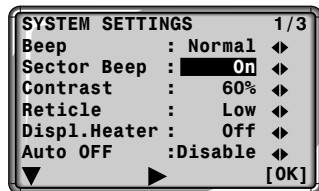

Beep

The beep is an acoustic signal after each key stroke.

Off	Beep switched off
Normal	Beep switched on
Loud	Increased volume

Sector Beep

- Off Sector beep switched off.
- On Sector beep sounds at right angles (0°, 90°, 180°, 270° or 0, 100, 200, 300 gon)

Example Sector Beep:

From 95.0 to 99.5 gon (or from 105.0 to 100.5 gon) a "Fast beep" sounds whilst from 99.5 to 99.995 gon (or from 100.5 to 100.005 gon) a "Permanent beep" sounds.

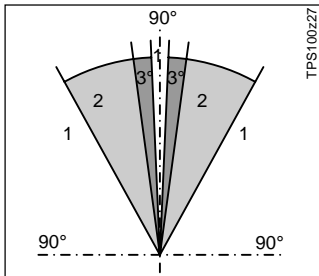

- 1 No beep
- 2 Fast beep (interrupted)
- 3 Permanent beep

Display contrast

10% Setting the display contrast in 10% steps;

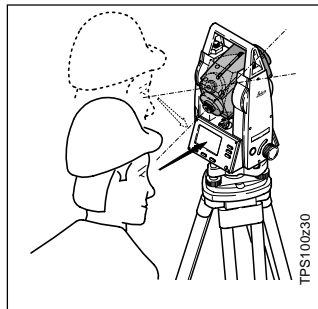

The readability of LCDs is influenced by external conditions (temperature, lighting) and by the reading angle (see figure). The display contrast can be adapted step by step until the optimum readability is achieved.



System Settings, continued

Reticle illumination

The reticle illumination is only switched on if the display illumination is on.

( + ).

Low reticle illumination dimmed
Medium average brightness
High strong illumination

Display heater

Off Display heater is switched off.

On Display heater is automatically activated when the display illumination is on and the instrument temperature is $< -5^{\circ}\text{C}$.

Auto OFF

Disable Function is deactivated and the instrument is permanently operating. The battery will not last for as long.

Enable The instrument is switched off after 15 minutes without any action (= no key pressed; V and Hz angle deviation $\leq \pm 3^{\circ}$ / $\pm 600\text{cc}$).

Sleep The instrument switches to economy mode after 15 minutes. Instrument is recovered by [OK].

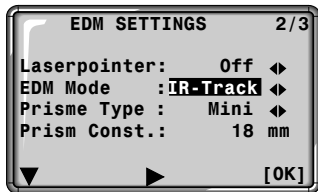

Laserpointer

- Off Visible laser beam is switched off.
- On Visible laser beam for defining the target point is switched on.

EDM Mode

The EDM Mode is selected according to the desired distance measurement accuracy and the prism type that is being used. Depending on selected measuring mode the selection prism types are different. With TCR instruments settings for measurements with visible EDM mode (RL = reflectorless) are available in addition to the settings for measurement with invisible EDM mode (IR = infrared) (see following).

RL-Standard

Distance measurements without prisms with a target distance up to 80 m. (5 mm + 3 ppm)*

RL-Track

Continuous distance measurement without prisms with a target distance up to 80 m. (5 mm + 3 ppm)*



With the RL-EDM each object in the beam is measured (possibly branches, cars, etc.)..

* accuracy
ppm = mm / km

EDM Settings, continued

IR-Standard

For distance measurements with prisms with a target distance up to 500 m.
(5 mm + 3 ppm)*

IR-Track



Continuous distance measurement with prisms up to 500 m.
(5 mm + 3 ppm)*

IR-Tape

Distance measurement using Retro targets with a target distance up to 250 m.
(5 mm + 3 ppm)*

* accuracy
ppm = mm / km

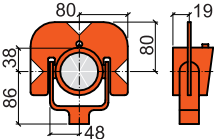
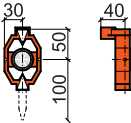
Prism type

Leica Geosystems Prisms (Basic Series)		Constants [mm]
Round prism GPR111		0.0
Miniprism GMP111		+17.5
Reflective targets		+34.4
USER is set at "Prismconst" (Example next page)		--
RL (Reflectorless)		+34.4

Prism constant

Entry of a user specific prism constant (refer to chapter "User Entries").

Input can only be made in [mm].

Formula:

Prism constant to be entered =
-mm + 34.4

Example:

Non-Leica Geosystems prism
constant = 14 mm

=>Prism constant to be entered
= -14 + 34.4 = **20.4**

Limit value:

-999 mm to +999 mm

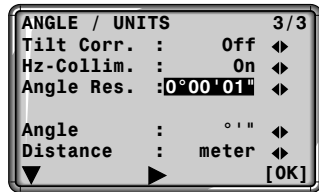

Tilt Correction

- Off Compensator switched off.
- On Compensator (2 axes) switched on. V-angles relate to plumb line and the Hz-angles are corrected for the tilt of the standing axis.

If the instrument is used on an unstable base (e.g. shaking platform, ship, etc.) **the compensator should be switched off.**

This avoids the compensator drifting out of its measuring range and interrupting the measuring process by indicating an error.



The compensator setting remains active even after the instrument is switched off.

Angle Settings, continued

Hz collimation

Off Hz-collimation is switched off.

On Hz-collimation is switched on.

If option "Hz-collimation ON" is active, each measured Hz-angle is corrected relative to the V-angle.

For normal operation the Hz-collimation remains switched on.



Find more information about the Hz-collimation in section "*Determining instrument errors*".

Resolution

The displayed angle format can be selected in three steps.

- **For 360⁰⁰⁰":**
0° 00' 01" / 0° 00' 05" / 0° 00' 10"
- **For 360°:**
0.001° / 0.005° / 0.01°
- **For gon:**
0.001 gon / 0.005 gon / 0.01 gon
- **For mil:**
0.01 mil / 0.05 mil / 0.1 mil

Unit Settings

Angle



- **° ' " (degree sexagesimal)**
possible angle values:
0° to 359°59'59"
- **dec. deg (degree decimal)**
possible angle values:
0° to 359.999°
- **gon**
possible angle values:
0 gon to 399.999 gon
- **mil**
possible angle values:
0 to 6399.99mil

The setting of the angle units can be changed at any time. The actual displayed values are converted according to the selected unit.

Distance

meter	Meter
US-ft	US feet
INT-ft	International feet
ft-in1/8	US feet / inch / 1/8 inch

Useful information which can be called via menu. These are only indications of actual setting and cannot be changed here. All changes to settings must be carried out in menu "SETTINGS".

MENU ( + )



[OK]



1. Open the menu functions.
2. Select the menu command "SYSTEM INFORMATION".
3. Start "SYSTEM INFORMATION"
4. Change display

System Information, continued

SYSTEM INFO 1		1/2
Tilt Corr. :	Off	
Hz-Collim. :	On	
Hz-Direction :	Right	
Battery :	70%	
Instr. Temp. :	22°C	
Displ.Heater :	Aus	
[EXIT]		

Tilt Correction

Display of current compensator setting.

Off Tilt compensation switched off.

On Compensator (2 axes) switched on. V-angles relate to plumb line and the Hz-angles are corrected for the tilt of the standing axis.

Hz collimation

Off Hz-collimation is switched off.

On Hz-collimation is switched on.

Hz-angle direction

Right Hz set to "Right angle measurement" (= clockwise).

Left Hz set to "Left angle measurement" (= anticlockwise).

↶ "Left angle measurements" are only shown in the display.

Battery

Remaining battery power (e.g. 40%).

Instrument temperature

Measured instrument temperature (always in °C).

System Information, continued

Display heater (On/Off)

Off Display heater is switched off.

On The display heater is automatically activated when the display illumination is on and the instrument temperature is $< -5^{\circ}\text{C}$.

When the temperature increases again, the heating is automatically switched off.

Software versions

The instrument software is composed of different software packages. Depending on the package different versions are possible.

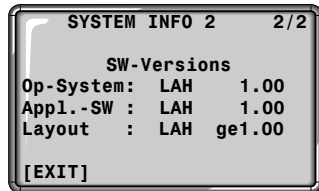

Op-System: Operating System
Appl.-SW: Applications,
functions and menu
Layout: User displays
(Language)



The display contents, particularly lines, contained in this description can vary in local versions of the software.

Checking and Adjusting

Electronically

The instruments are adjusted in the factory prior to shipping.

Instrument errors can change with time and temperature.



These errors should be determined before the instrument is used for the first time, before precision surveys, after long periods of transport, before and after long periods of work, and if the temperature changes by more than 10°C (18°F).



Before determining the instrument errors, level-up the instrument using the electronic bubble. The instrument should be secure and firm, and should be protected from direct sunlight in order to avoid thermal warming on one side only.

Line-Of-Sight Error (Hz-Collim.)

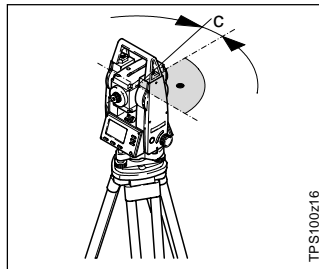

The line-of-sight error or collimation error (C) is the deviation from the perpendicular between the tilting axis and the line of sight.

The effect of the line-of-sight error to the Hz-angle increases with the vertical angle. For horizontal aimings the error of the Hz-angle equals the line-of-sight error.

Vertical Index Error (V-Index)

Determining Instrument Errors

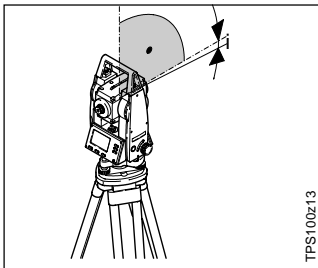

The vertical circle should read exactly 90° (100 gon) when the line of sight is horizontal. Any deviation from this figure is termed vertical index error (i).

By determining the vertical index error the electronic level is adjusted automatically.

The calibration contains the determination of the following instrument errors:

- Line-Of-Sight Error (Hz-collimation)
- Vertical Index Error (V-Index)
The electronic level is adjusted simultaneously.

MENU (\uparrow + **V/%**)

1. Open the menu functions.
- ▼ 2. Select the menu command "CALIBRATION".

[OK] 3. Start "CALIBRATION"

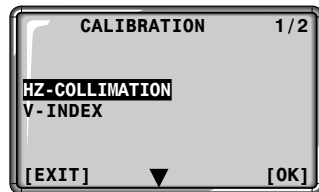

[OK] 4. Start "HZ-COLLIMATION"

or

- ▼ 4. Select the menu command "V-INDEX".
- [OK] 5. Start "V-INDEX"

Determining Instrument Errors, continued

For determining the Hz-collimation or the V-index it is necessary to measure in both telescope faces. The procedure can be started in any telescope face.

The user is guided clearly through the procedure. As a result, a wrong determination of instrument errors is eliminated.

Calibration data

 Overview of the last determined and saved values (Hz-collimation, V-index).

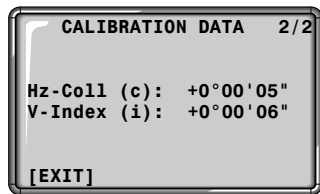

Buttons

[MEAS] Measurements are triggered exclusively by pressing this button . **DIST** is not active during calibration

[EXIT] Back to calibration menu without saving.

Determining The Line-Of-Sight Error (c)

1. Level up instrument exactly using the electronic level.
2. Start Hz-collimation (refer to p. 50).
3. Aim at a point approximately 100m from the instrument that is less than $\pm 4^{\circ}30'$ (5 gon) from the horizontal.

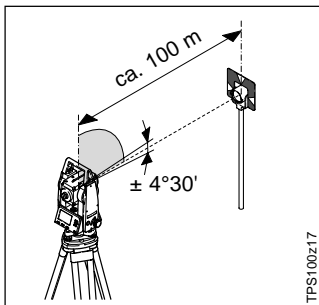

For checking the horizontal aiming Hz- and V-angles are displayed.

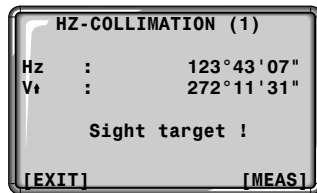

4. [MEAS] Trigger measurement.
5. Change telescope face and aim on point again.

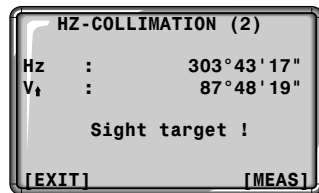
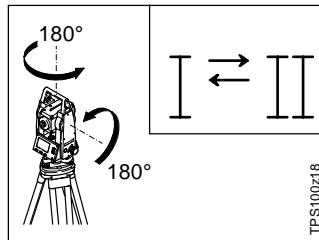

6. [MEAS] Trigger measurement again.

Determ. Line-Of-Sight Error, cont. Determining V-Index

7. Indication of previous and recomputed line-of-sight error.

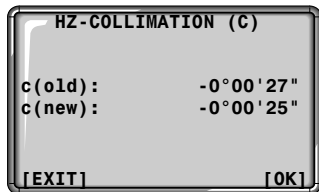

8. [OK] Accept new value
or
[EXIT] Reject new value.

1. Level up instrument exactly using the electronic level.
2. Start V-Index (refer to p. 50)
3. Aim at a point approximately 100m from the instrument that is less than $\pm 4^{\circ}30'$ (5 gon) from the horizontal.

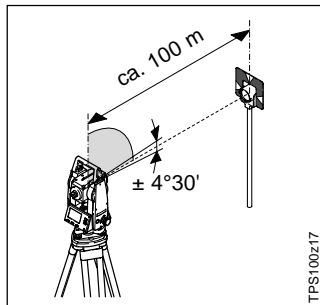

For checking the horizontal aiming HZ- and V-angles are displayed.

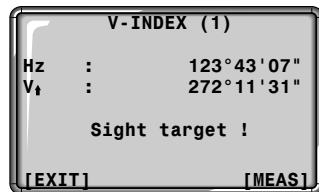

4. [MEAS] Trigger measurement.

Determining V-Index, continued

5. Change telescope position and aim on point again.

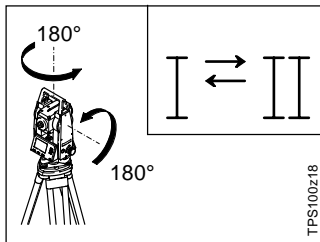

6. [MEAS] Trigger measurement again.
7. Indication of previous and recomputed V-index.

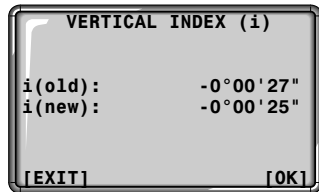

 By determining the vertical index error the electronic level is adjusted automatically.

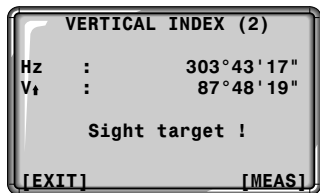

8. [OK] Accept new value
or
[EXIT] Reject new value.

Mechanical

Tripod

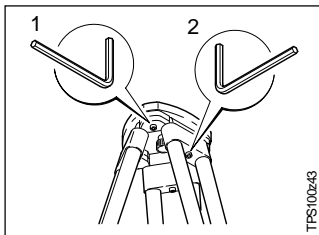

The connections between metal and timber components must always be firm and tight.

- Tighten the Allen screws (2) moderately.
- Tighten the articulated joints on the tripod head (1) just enough to keep the tripod legs open when you lift it off the ground.

Circular Level

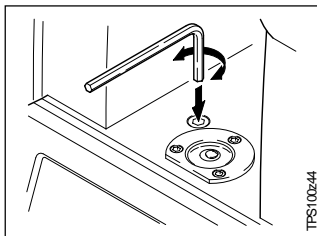

Level-up the instrument in advance with the electronic level. The bubble must be centered. If it extends beyond the circle, use the Allen key supplied to center it by turning the adjustment screws.



After adjustment no screw must be loose.

Circular Level on the Tribrach

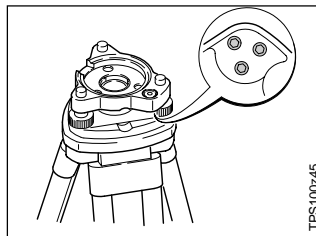

Level the instrument and then remove it from the tribrach. If the bubble is not centered, adjust it using the adjusting pin.

Turn the adjustment screws:

- to the left: the bubble approaches the screw
- to the right: the bubble goes away from the screw.

Laser Plummet

The laser plummet is integrated into the vertical axis of the instrument. Under normal circumstances setting of the laser plummet is not necessary. If an adjustment is necessary due to external influences the instrument has to be returned to any Leica service department.

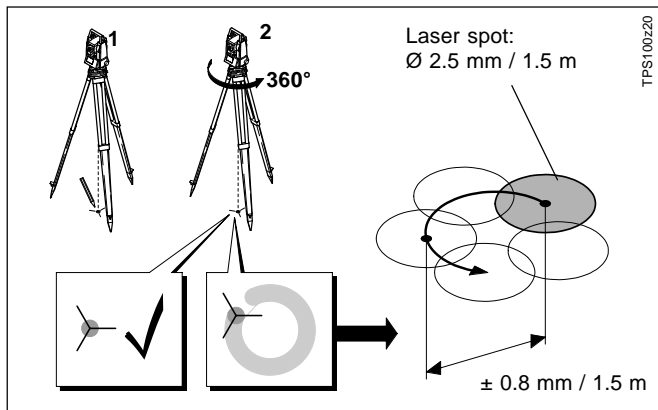

Checking by turning the instrument by 360°:

1. Install the instrument on the tripod approx. 1.5 m above ground and level up.
2. Switch on laser plummet and mark the centre of the red spot.
3. Turn instrument slowly through 360° and observe the red laser spot.

Laser Plummet, continued

Inspecting the laser plummet should be carried out on a bright, smooth and horizontal surface (e.g. a sheet of paper).

If the centre of the laser spot makes a clear circular movement or if the centre of the point is moving away more than 1mm from the first marked point an adjustment is possibly necessary. Call your nearest Leica service department.

Depending on brightness and surface the size of the laser spot can vary. At a distance of 1.5 m an average value of 2.5 mm diameter must be estimated.

The maximum diameter of the circular movement of the centre of the laser spot should not exceed +/- 0.8 mm at a distance of 1.5 m.

Reflectorless EDM

The red laser beam used for measuring without reflector is arranged coaxially with the line of sight of the telescope, and emerges from the objective port. If the instrument is well adjusted, the red measuring beam will coincide with the visual line of sight. External influences such as shock or large temperature fluctuations can displace the red measuring beam relative to the line of sight.



The direction of the beam should be inspected before precise measurement of distances is attempted, because an excessive deviation of the laser beam from the line of sight can result in imprecise distance measurements.

Reflectorless EDM, continued

Inspection

A target plate is provided. Set it up between five and 20 metres away with the grey reflective side facing the instrument. Move the telescope to face II. Switch on the red laser beam by activating the laser-point function. Use the telescope crosshair to align the instrument with the centre of the target plate, and then inspect the position of the red laser spot on the target plate. Generally speaking the red spot cannot be seen through the telescope, so look at the target plate from just above the telescope or from just to the side of it.

If the spot illuminates the cross, the achievable adjustment precision has been reached. If it lies outside the limits of the cross, the direction of the beam needs to be adjusted.

If the spot on the more reflective side of the plate is too bright (dazzling), use the white side instead to carry out the inspection.

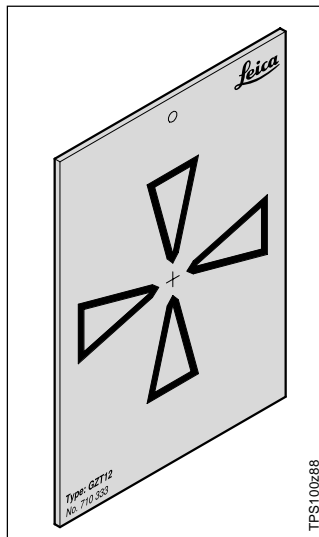

Reflectorless EDM, continued

Adjusting the Direction of the Beam

Pull the two plugs out from the adjustment ports on the top side of the telescope housing.

To correct the height of the beam, insert the screwdriver into the rear adjustment port and turn it clockwise (spot on target plate moves obliquely upwards) or anticlockwise (spot moves obliquely downwards). To correct the beam laterally, insert the screwdriver into the front adjustment port and turn it clockwise (spot moves to the right) or anticlockwise (spot moves to the left).

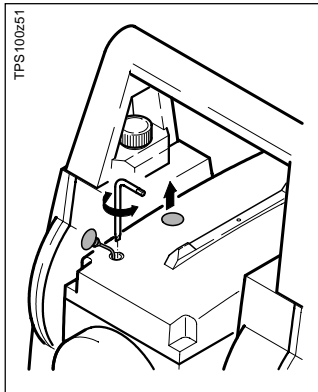

Throughout the adjustment procedure, keep the telescope pointing to the target plate.

After each field adjustment, replace the plugs in the adjustment ports to keep out damp and dirt.

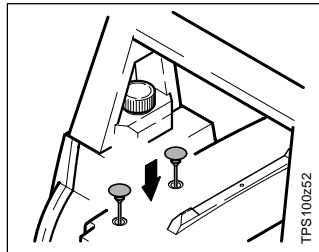

The following directions should enable the person responsible for the TC(R)110, and the person who actually uses the instrument, to anticipate and avoid operational hazards.

The person responsible for the instrument must ensure that all users understand these directions and adheres to them.

Permitted Uses

The electronic total stations are intended to the following applications:

- Measuring horizontal and vertical angles
- Measuring distances
- Visualising the standing axis (with laser plummet)

Adverse Uses

- Use of the total station without previous instruction
- Use outside of the intended limits
- Disabling safety systems and removal of hazard notices
- Opening the instrument using tools (screwdriver, etc.), unless this is specifically permitted for certain functions
- Modification or conversion of the instrument
- Use after misappropriation
- Use with accessories from other manufacturers without the prior express approval of Leica Geosystems

Adverse Uses, continued

- Aiming directly into the sun
- Inadequate safeguards at the surveying site (e.g. when measuring on roads, etc.)
- Controlling machines, or controlling moving objects or similar, with the integrated EDM (visible laser)
- Deliberate dazzling of third parties



WARNING:

Adverse use can lead to injury, malfunction, and material damage.

It is the task of the person responsible for the instrument to inform the user about hazards and how to counteract them.

The electronic total stations are not to be used until the user has been properly instructed how to use them.

Limits of Use

Refer to section "Technical Data".

Environment:

Suitable for use in an atmosphere appropriate for permanent human habitation: not suitable for use in aggressive or explosive environments. Use in rain is permissible for limited periods.

Temperature limits

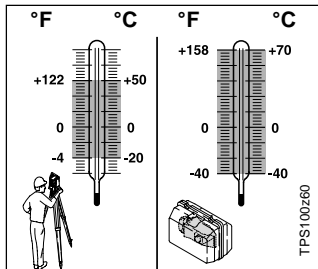

Responsibilities

Area of responsibility for the manufacturer of the original equipment Leica Geosystems AG, CH-9435 Heerbrugg (hereinafter referred to as Leica Geosystems):

Leica Geosystems is responsible for supplying the product, including the User Manual and original accessories, in a completely safe condition.

Responsibilities of the manufacturers of non-Leica Geosystems accessories:



The manufacturers of non-Leica Geosystems accessories for the electronic total stations are responsible for developing, implementing and communicating safety concepts for their products, and are also responsible for the effectiveness of those safety concepts in combination with the Leica Geosystems product.

Responsibilities of the person in charge of the instrument:



WARNING: The person responsible for the instrument must ensure that it is used in accordance with the

instructions. This person is also accountable for the training and deployment of personnel who use the instrument and for the safety of the equipment when in use.

The person in charge of the instrument has the following duties:

- To understand the safety instructions on the product and the instructions in the User Manual.
- To be familiar with local regulations relating to accident prevention.
- To inform Leica Geosystems immediately if the equipment becomes unsafe.

Hazards of Use

**WARNING:**

The absence of instruction, or the inadequate imparting of instruction, can lead to incorrect or adverse use, and can give rise to accidents with far-reaching human, material, financial and environmental consequences.

Precautions:

All users must follow the safety directions given by the manufacturer and the directions of the person responsible for the instrument.

**WARNING:**

The battery charger is not designed for use under wet and severe conditions. If instrument becomes wet it may cause you to receive an electric shock.

Precautions:

Use charger only in dry rooms and protect instrument from humidity. Do not use instruments in a wet environment.

**WARNING:**

If you open the charger, either of the following actions may cause you to receive an electric shock:

- Touching live components
- Using the charger after incorrect attempts to carry out repairs

Precautions:

Do not open the charger. Only a Leica Geosystems-approved service technician is entitled to repair it.

Hazards of Use, continued



DANGER:

Because of the risk of electrocution, it is very dangerous to use reflector poles and extensions in the vicinity of electrical installations such as power cables or electrical railways.

Precautions:

Keep at a safe distance from electrical installations. If it is essential to work in this environment, first contact the safety authorities responsible for the electrical installations and follow their instructions.



WARNING:

By surveying during a thunderstorm you are at risk from lightning.

Precautions:

Do not carry out field surveys during thunderstorms.



Hazards of Use, continued



CAUTION:

Be careful not to point the instrument directly towards the sun, because the telescope functions as a magnifying lens and can injure your eyes or damage the distance measuring device and the Guide Light EGL.

Precautions:

Do not point the telescope directly at the sun.



WARNING:

During target recognition or stakeout procedures there is a danger of accidents occurring if the user does not pay attention to the environmental conditions (e.g. obstacles, excavations or traffic).

Precautions:

The person responsible for the instrument must make all users fully aware of the existing dangers.



WARNING:

Inadequate securing of the surveying site can lead to dangerous situations, for example in traffic, on building sites and at industrial installations.

Precautions:

Always ensure that the surveying site is adequately secured. Adhere to the local regulations governing accident prevention and road traffic.

Hazards of Use, continued



CAUTION:

If a target lamp accessory is used with the instrument the lamp's surface temperature may be extreme after a long working period. It may cause pain if touched. Replacing the halogen bulb before the lamp has been allowed to cool down may cause burning to the skin or fingers.

Precautions:

Use appropriate heat protection such as gloves or woollen cloth before touching the lamp, or allow the lamp to cool down first.



WARNING:

If computers intended for use indoors are used in the field there is a danger of electric shock.

Precautions:

Adhere to the instructions given by the computer manufacturer with regard to field use in conjunction with Leica Geosystems instruments.



CAUTION:

During the transport or disposal of charged batteries it is possible for inappropriate mechanical influences to constitute a fire hazard.

Precautions:

Before transporting or disposing of equipment, discharge the battery (e.g. by running the instrument in tracking mode until the batteries are exhausted).

Hazards of Use, continued



WARNING:

If the equipment is improperly disposed of, the following can happen:

- If polymer parts are burnt, poisonous gases are produced which may impair health.
- If batteries are damaged or are heated strongly, they can explode and cause poisoning, burning, corrosion or environmental contamination.

- By disposing of the equipment irresponsibly you may enable unauthorized persons to use it in contravention of the regulations, exposing themselves and third parties to the risk of severe injury and rendering the environment liable to contamination.
- Leakage of silicone oil from the compensator can damage the optical and electronic subassemblies.

Precautions:

Dispose of the equipment appropriately in accordance with the regulations in force in your country. Always prevent access to the equipment by unauthorized personnel.

Hazards of Use, continued



CAUTION:

If the accessories used with the instrument are not properly secured, and the equipment is subjected to mechanical shock (e.g. blows, falling etc.), the equipment may be damaged, safety devices may be ineffective or people may sustain injury.

Precautions:

When setting-up the instrument, make sure that the accessories (e.g. tripod, tribrach, etc.) are correctly adapted, fitted, secured and locked in position. Avoid subjecting the equipment to mechanical shock. Never position the instrument on the tripod baseplate without securely tightening the central fixing screw. If the screw is loosened always remove the instrument immediately from the tripod.



CAUTION:

Watch out for erroneous measurements if the instrument is defective or if it has been dropped or has been misused or modified.

Precautions:

Periodically carry out test measurements and perform the field adjustments indicated in the User Manual particularly after the instrument has been subjected to abnormal use and before and after important measurements.

Laser Classification



CAUTION:

Allow only authorized Leica Geosystems service workshops to service the instrument.

Integrated EDM (Infrared Laser)

The EDM module built into the total stations produces an invisible infra-red laser beam which emerges from the telescope objective.

The product is a Class 1 laser product in accordance with:

- IEC 825-1 : 1993 "Radiation safety of laser products".
- EN 60825-1: 1994 "Radiation safety of laser products".

The product is a Class I laser product in accordance with:

- FDA 21CFR Ch.I §1040 : 1988 (US Department of Health and Human Service, Code of Federal Regulations)

Class 1/I laser products are safe under reasonably foreseeable conditions of operation and are not harmful to the eyes provided that the products are used and maintained in accordance with the instructions.



WARNING:

It can be dangerous to look into the beam with optical equipment (e.g. binoculars, telescopes).

Precautions:

Do not look directly into the beam with optical equipment.

Integrated EDM (Infrared Laser), continued



Beam divergence	1.8 mrad
Pulse duration	800 ps
Maximum radiant power	0.33 mW
Maximum radiant power per pulse	4.12 mW
Measurement uncertainty	± 5%

Type: TC.... **Art.No.:**

Power: 12V/6V ---, 1A max

Leica Geosystems AG

CH-9435 Heerbrugg

Manufactured: 2000

Made in Switzerland **S.No.:**



This laser product complies with 21CFR 1040 as applicable.

This device complies with part 15 of the FCC Rules. Operation is subject to the following two conditions: (1) This device may not cause harmful interference, and (2) this device must accept any interference received, including interference that may cause undesired operation.

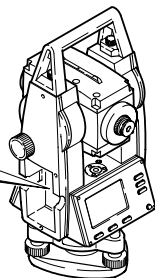

TPS100z54

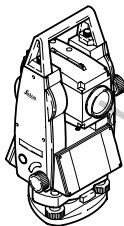

Infrared laser beam exit (invisible).

TPS100z11

Integrated EDM (Visible Laser)

As an alternative to the infrared beam, the EDM incorporated into the total station produces a visible red laser beam which emerges from the telescope objective.

The product is a Class 2 laser product in accordance with:

- IEC825-1 : 1993 "Radiation safety of laser products"
- EN60825-1 : 1994 "Radiation safety of laser products"

The product is a Class II laser product in accordance with:

- FDA 21CFR Ch.I §1040 : 1988 (US Department of Health and Human Service, Code of Federal Regulations)

Class 2/II laser products:
Do not stare into the beam or direct it unnecessarily at other persons. Eye protection is normally afforded by aversion responses including the blink reflex.



WARNING:

It can be dangerous to look into the beam with optical equipment (e.g. binoculars, telescopes).

Precautions:

Do not look directly into the beam with optical equipment.

Labelling

<i>Max. emitted Power :</i>	<i>0.95mW</i>
<i>Emitted Wavelength :</i>	<i>620-690nm</i>
<i>Standard applied :</i>	<i>EN60825-1:1994-07</i>
	<i>IEC825-1 : 1993-11</i>

Integrated EDM (Visible Laser), continued

AVOID EXPOSURE
Laser radiation is emitted from this aperture

CAUTION
LASER RADIATION - DO NOT STARE INTO BEAM
620-690nm/0.95mW max.
CLASS II LASER PRODUCT

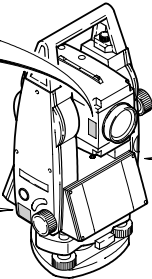

Type: TC.... **Art.No.:**

Power: 12V/6V ~~, 1A max

Leica Geosystems AG

CH-9435 Heerbrugg

Manufactured:2000

Made in Switzerland **S.No.:**

CE

This laser product complies with 21CFR 1040 as applicable.

This device complies with part 15 of the FCC Rules. Operation is subject to the following two conditions: (1) This device may not cause harmful interference, and (2) this device must accept any interference received, including interference that may cause undesired operation.

2





TPS100z53

Beam divergence	0.15 x 0.35 mrad
Pulse duration	800 ps
Maximum radiant power	0.95 mW
Maximum radiant power per pulse	12 mW
Measurement uncertainty	± 5%

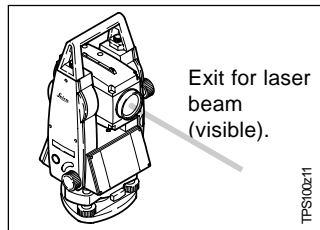

TPS100z11

Laser Plummet

The integrated laser plummet produces a visible laser beam which emerges from the base of the instrument.

The product is a Class 2 laser product in accordance with:

- IEC825-1 : 1993 "Radiation safety of laser products"
- EN60825-1 : 1994 "Radiation safety of laser products"

The product is a Class II laser product in accordance with:

- FDA 21CFR Ch.I §1040 : 1988 (US Department of Health and Human Service, Code of Federal Regulations)

Class 2/II laser products:
Do not stare into the beam or direct it unnecessarily at other persons. Eye protection is normally afforded by aversion responses including the blink reflex.

Labelling

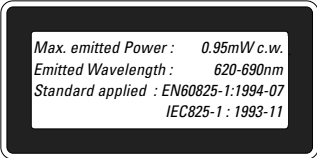

Max. emitted Power : 0.95mW c.w.
Emitted Wavelength : 620-690nm
Standard applied : EN60825-1:1994-07
IEC825-1 : 1993-11

Laser Plummet, continued

Type: TC... Art.No.:

Power: 12V/6V ~~, 1A max

Leica Geosystems AG

CH-9435 Heerbrugg

Manufactured: 2000

Made in Switzerland S.No.:



This laser product complies with 21CFR 1040 as applicable.

This device complies with part 15 of the FCC Rules. Operation is subject to the following two conditions: (1) This device may not cause harmful interference, and (2) this device must accept any interference received, including interference that may cause undesired operation.

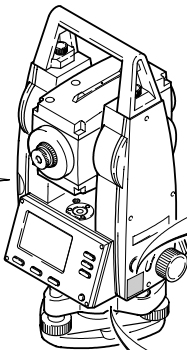

CAUTION
LASER RADIATION - DO NOT
STARE INTO BEAM
620-690nm/0.95mW max.
CLASS II LASER PRODUCT



AVOID EXPOSURE
Laser radiation is emitted
from this aperture

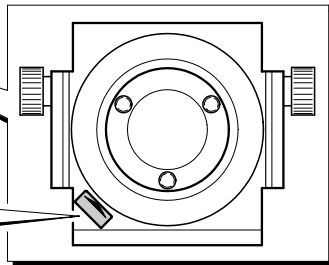

TPS100255

Laser Plummet, continued

Beam divergence	0.16 x 0.6 mrad
Pulse duration	c.w.
Maximum radiant power	0.95 mW
Maximum radiant power per pulse	n/a
Measurement uncertainty	±5%

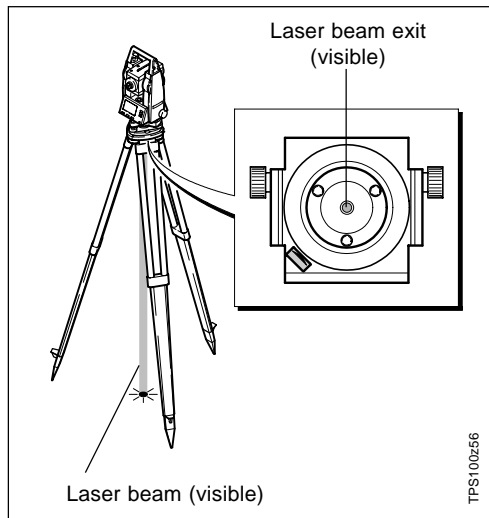

Electromagnetic Compatibility (EMC)

The term "electromagnetic compatibility" is taken to mean the capability of the instrument to function correctly in an environment where electromagnetic radiation and electrostatic discharges are present, and without causing electromagnetic disturbances in other equipment.



WARNING:

Electromagnetic radiation can cause disturbances in other equipment.

Although electronic total stations meet the strict regulations and standards which are in force in this respect, Leica Geosystems cannot completely exclude the possibility that other equipment may be disturbed.



CAUTION:

There is a risk that disturbances may be caused in other equipment if the total station is used in conjunction with accessories from other manufacturers, e.g. field computers, personal computers, walkie-talkies, non-standard cables, external batteries.

Precautions:

Use only the equipment and accessories recommended by Leica Geosystems. When combined with total stations, they meet the strict requirements stipulated by the guidelines and standards. When using computers and walkie-talkies, pay attention to the information about electromagnetic compatibility provided by the manufacturer.

Electromagnetic Compatibility (EMC), continued



CAUTION:

Disturbances caused by electromagnetic radiation can result in the tolerance limits for measurements being exceeded.

Although the total stations meet the strict regulations and standards which are in force in this connection, Leica Geosystems cannot completely exclude the possibility that the total station may be disturbed by very intense electromagnetic radiation, e.g. near radio transmitters, walkie-talkies, diesel generators, power cables. Check the plausibility of results obtained under these conditions.

FCC Statement (Applicable in U.S.)



WARNING:

This equipment has been tested and found to comply with the limits for a Class B digital device, pursuant to part 15 of the FCC Rules. These limits are designed to provide reasonable protection against harmful interference in a residential installation. This equipment generates, uses and can radiate frequency energy and, if not installed and used in accordance with the instructions, may cause harmful interference to radio communications. However, there is no guarantee that interference will not occur in a particular installation.

If this equipment does cause harmful interference to radio or television reception, which can be determined by turning the equipment off and on, the user is encouraged to try to correct the interference by one or more of the following measures:

- Reorient or relocate the receiving antenna.
- Increase the separation between the equipment and receiver.
- Connect the equipment into an outlet on a circuit different from that to which the receiver is connected.

- Consult the dealer or an experienced radio/TV technician for help.

FCC Statement (Applicable in U.S.), continued



WARNING:

Changes or modifications not expressly approved by Leica Geosystems for compliance could void the user's authority to operate the equipment.

Product labelling:

This device complies with part 15 of the FCC Rules. Operation is subject to the following two conditions: (1) This device may not cause harmful interference, and (2) this device must accept any interference received, including interference that may cause undesired operation.

Type: TC... **Art.No.:**
Power: 12V/6V ---, 1A max
Leica Geosystems AG
CH-9435 Heerbrugg
Manufactured: 2000
Made in Switzerland **S.No.:**



This laser product complies with 21CFR 1040 as applicable.

This device complies with part 15 of the FCC Rules. Operation is subject to the following two conditions: (1) This device may not cause harmful interference, and (2) this device must accept any interference received, including interference that may cause undesired operation.

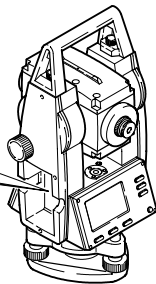

TPS100z54

Transport

When transporting or shipping the equipment always use the original Leica Geosystems packaging (transport case and shipping cardboard).



After a longer period of storage or transport of your instrument always check the field adjustment parameters indicated in this manual before using the instrument.

In the Field

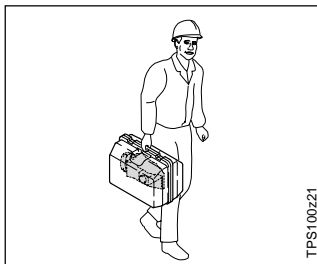

When transporting the equipment **in the field**, always make sure to

- either carry the instrument in its original transport case or,

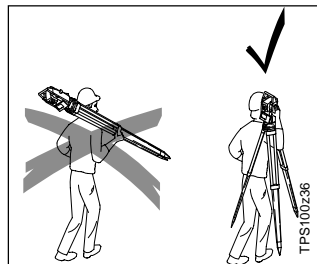

- carry the tripod with its legs splayed across your shoulder, keeping the attached instrument upright.

Inside Vehicle

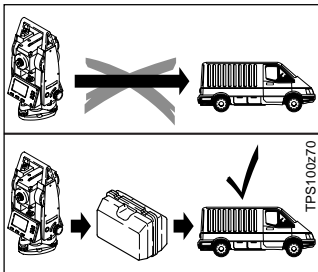

Never transport the instrument loose **inside the vehicle**. The instrument can be damaged by blows and vibrations. It must always be transported in its case and be properly secured.

Shipping

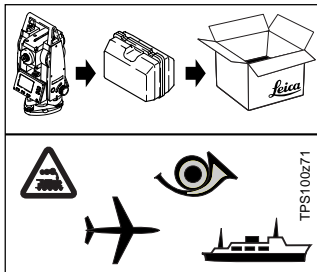

For shipping the instrument by **rail, aircraft or ship** use the Leica Geosystems original packaging (transport case or shipping cardboard) or another suitable packaging securing the instrument against blows and vibrations.

Storage

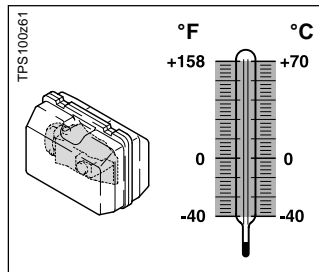

 When storing the equipment, particularly in summer and inside a vehicle, take the **temperature limits** into account.

When storing the instrument inside a building also use the transport case (if possible, in a safe place).

Cleaning

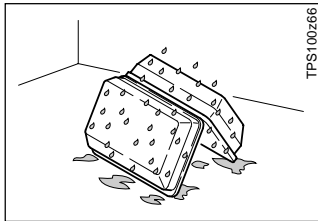

☞ If the instrument becomes wet, leave it unpacked. Wipe down, clean, and dry the instrument (at not more than 40 °C/ 108°F), transport case, foam inserts, and accessories. Pack up the equipment only when it is perfectly dry.

When using the instrument in the field always close the transport case.

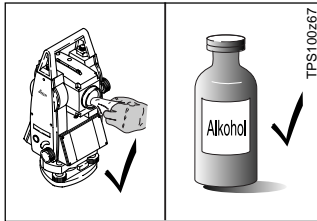

☞ Objective, eyepiece and prisms:

- Blow dust off lenses and prisms.
- Never touch the glass with fingers.
- Use only a clean, soft and lint-free cloth for cleaning. If necessary, moisten the cloth with pure alcohol.

Use no other liquids; these may attack polymer components.

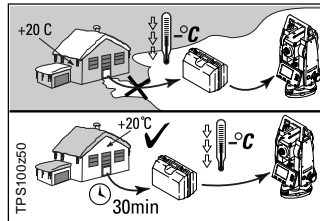

☞ Fogging of prisms: Reflector prisms that are cooler than the ambient temperature tend to fog. It is not enough simply to wipe them. Keep them for some time inside your jacket or in the vehicle to allow them to adjust to the ambient temperature.

Messages and Warnings

Overview of frequent messages and warnings.

Message / Warning	Meaning / Cause	Measure
System		
Low battery !	The battery has reached 20% of its capacity.	Change or charge battery.
Sleep mode ! Press OK to wake up!	Auto OFF is set to "Sleep" in the system settings.	Press [OK].
Shut down !	Auto OFF is set to "Enable" in the system settings.	Change setting.
Temperature out of range !	The ambient temperature is outside the specifications (-20°C to +50°C; -4°F to +122°F). The instrument is switched off automatically (safety function !)	Cool or warm instrument, as applicable.
Contact service !	A system error occurred requiring a service.	Rectifying this error by your local Leica Service station.

Messages and Warnings, continued

Message / Warning	Meaning / Cause	Measure
Distance measurement		
No Laserpointer installed !	The visible laser beam for defining the target point cannot be switched on because an instrument of the type TC is being used.	Use instrument of type TCR.
Weak Signal ! Error Nr. 6 or 54	The distance measurement could not be triggered within the given time (distance too long, beam interrupted, ...).	Check pointing or reduce range. Repeat measurement.
Signal too strong !	The EDM signal is too strong (e.g. measurement with RL-EDM to prisms).	Change EDM type or target type.
Angle measurement		
Instrument tilt ! Level instrument !	The Compensator is out of measuring range.	Level instrument or switch off compensator.

Messages and Warnings, continued

Message / Warning	Meaning / Cause	Measure
Calibration		
V-Angle not suitable for calibration ! (Check V-Angle or face)	Aiming tolerance not met or telescope position/face not changed.	The target point must be approximately in the horizontal plane $\pm 4^{\circ}30'$. Confirmation of the message required.
Result out of tolerance and will be rejected !	Computed values out of tolerance. Previous values retained.	Repeat measurements. Confirmation of the message required.
Hz-Angle out of limit !	Hz-angle in second face/telescope pos. deviates more than $4^{\circ}30'$ from the target point.	Aim on the target point with an accuracy of min. $4^{\circ}30'$. Confirmation of the message required.
Unstable condition or instrument is tilted ! Try again !	Measurement error appeared (e.g. instable set up or period between measuring in telescope position I and II too long).	Repeat the process. Confirmation of the message required.

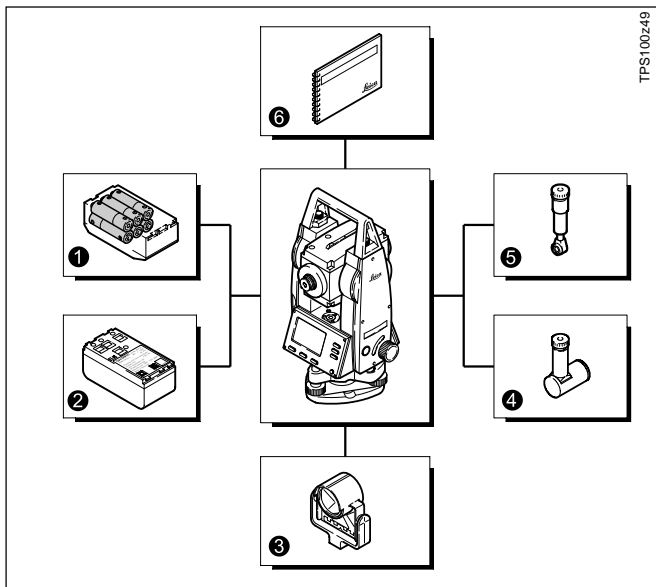

- 1) **Battery adapter GAD39**
(Art. Nr. 712156)
- 2) **Battery GEB121**
(Art. Nr. 667123)
- 3) **Leica round prism GPR111**
(Art. Nr. 641618)
- 4) **Eyepiece for steep angles**
(Art. Nr. 376236)
- 5) **Diagonal eyepiece GFZ1**
(Art. Nr. 363880)
- 6) **Booklet:**
Surveying made easy
(available in English
(Art. Nr. 722510) and
German (Art. Nr. 722383))

Technical Data

Telescope

- Transits fully
- Magnification:
30x
- Image:
upright
- Free objective aperture:
40 mm
- Shortest focussing
distance:
1.7 m (5.6 ft)
- Focusing:
fine
- Field of view:
1°30' (1.7gon)
- Telescope field of view at
100 m: 2.6 m

Angle measurement

- absolute, continuous,
- Updates each 0.3 seconds
- Units selectable
360° sexagesimal, 400gon,
360° decimal, 6400 mil, V%,
±V
- Accuracy standard deviation
(acc. to DIN 18723 / ISO
12857)
10" (3 mgon)
5 mm @ 100 m
1/4 inch @ 400 ft
- Smallest display resolution
gon: 0.001
360d: 0.001
360s: 1"
mil: 0.01

Level sensitivity

- Circular level:
6'/2 mm
- Electronic bubble:
20"/2mm

Laser plummet

- In alidade, turns with
instrument
- Accuracy:
max. rot.-ø of laser spot:
± 0.8 mm/1.5m
- Point-ø of laser spot:
2.5mm / 1.5m

Technical Data, continued

Compensator

- 2-axis-oil compensator
- Setting range
±4' (0.07 gon)
- Setting accuracy
3" (1 mgon)

Keyboard

- Tilt angle: 70°
- Base area: 110x75 mm
- No. of buttons: 7

Display

- Backlit
- Heatable (Temp. < -5°C)
- LCD: 144x64 Pixel
- 8 lines with 24 characters
each

Type of tribrach

- Tribrach removable GDF101
(red)
Thread-ø: 5/8"
(DIN 18720 / BS 84)
- Tribrach shiftable GUS75
(red)
Thread-ø: M35x2
(DIN 13)
with adapter 5/8"

Dimensions

- Instrument:
Height (including tribrach and
carrying handle):
 - with tribrach GDF101
360 mm ± 5 mm
 - with tribrach GUS75
358 mm ± 5 mm
- Width: 150 mm
- Length: 145 mm
- Case: 468x254x355 mm
(LxWxH)

Tilting axis height

- without tribrach 196 mm
- with tribrach GDF101
240 mm ± 5 mm
- with tribrach GUS75
238 mm ± 5 mm

Technical Data, continued

Weight

including battery GEB111 and
tribrach:

- with GDF101 4.88 kg
- with GUS75 5.10 kg

without battery and tribrach:

3.94 kg

Number of measurements

GEB111:

- Angle: > 4 h
- Distance: > 1000

GEB121:

- Angle: > 8 h
- Distance: > 2000

Automatic corrections

- Line-of-sight error Yes
- Vertical-index error Yes
- Earth curvature Yes
- Refraction Yes
- Tilt correction Yes

Power supply

- Battery GEB111: NiMh
 (0% Cadmium)
Voltage: 6V, 1800 mAh
- Battery GEB121: NiMh
 (0% Cadmium)
Voltage: 6V, 3600 mAh
- Battery adapter GAD39:
 6 x LR6/AA/AM3, 1.5V,
 only alkaline batteries

Temperature range

- Storage: -40°C bis +70°C
 -40°F bis +158°F
- Operating: -20°C bis +50°C
 -4°F bis +122°F

Technical Data, continued

Distance measurement (IR: infrared)

- Type infrared
- Carrier wavelength 0.780 μm
- Measuring system special frequency system
basis 100 MHz \pm 1.5 m
- EDM type coaxial
- Display (least count) 1 mm

EDM measuring program	Time per measurement
IR-Standard	<0.5 sec.
IR-Track	<0.3 sec.
IR-Tape	<0.5 sec.

- Accuracy
The distance measuring accuracy is 5mm + 3ppm for the listed EDM measuring programs* (6mm @ 300m; 1/4 inch @ 1500ft).
* ppm = mm / km



Beam interruptions, severe heat shimmer and moving objects within the beam path can result in deviations from the specified accuracy.

	Range		
	Miniprism	Round prism	Tape 60mm x 60mm
1	400 m (1300 ft)	400 m (1300 ft)	150 m (500 ft)
2	500 m (1600 ft)	500 m (1600 ft)	250 m (800 ft)
3	500 m (1600 ft)	500 m (1600 ft)	250 m (800 ft)

- 1) Strong haze, visibility 5km; or strong sunlight, severe heat shimmer
- 2) Light haze, or moderate sunlight, slight heat shimmer, visibility about 20km
- 3) Overcast, no haze, visibility about 40km; no heat shimmer

Technical Data, continued

Distance measurement (RL: reflectorless)

- Type visible red laser
- Carrier wavelength 0.670 μm
- Measuring system special frequency system
basis 100 MHz \pm 1.5 m
- EDM type coaxial
- Display (least count) 1 mm
- Laser spot size: approx. 7 x 14 mm / 20 m
ca. 10 x 20 mm / 50 m
- Range of measurement: 1.5 m to 80 m
(to target plate art.no. 710333)
- Prism constant: + 34.4 mm

EDM measuring program	Time per measurement
RL-Standard	3.0 sec. +1.0 sec./10m > 30m
RL-Track	1.0 sec. +0.3 sec./10m > 30m

- Accuracy
The distance measuring accuracy is 5mm + 3ppm for the listed EDM measuring programs (6mm @ 300m; 1/4 inch @ 1500ft).



Beam interruptions, severe heat shimmer and moving objects within the beam path can result in deviations from the specified accuracy.

	Range	
Atmospheric conditions	No reflector (white target)*	No reflector (gray, albedo 0.25)*
4	60 m (200 ft)	30 m (100 ft)
5	80 m (260 ft)	50 m (160 ft)
6	80 m (260 ft)	50 m (160 ft)

* Kodak Grey Card used with exposure meter for reflected light

- 4) Object in strong sunlight, severe heat shimmer
- 5) Object in shade, or sky overcast
- 6) Day, night and twilight

A	Abbreviations	11	C	Calibration	85
	Accessories	86		Calibration data	51
	Accuracy	87, 90		Care	80
	Accurate levelling-up	29		Centring with laser plummet	28
	Adjusting	49		Centring with shifting tribrach	31
	Adjusting the direction of the beam	59		Change display	13, 32
	Angle	45		Character set	19
	Angle measurement	36, 84, 87		Checking	49
	Angle settings	44		Choice fields	20
	Area of applicability	8		Circular level	10, 55
	Atmospheric conditions	91		Circular level on the tribrach	55
	Auto OFF	41		Cleaning	82
	Automatic corrections	89		Coarse level-up	28
B	Battery	22, 47		Collimation axis	11
	Battery adapter GAD39	10, 22, 86		Compensator	12, 16, 88
	Battery capacity	16		Coordinate measurement	34
	Battery charger GKL111	23			
	Battery GEB111	10			
	Battery GEB121	10, 86			
	Beep	39			
	Buttons	15, 51			

Index, continued

D	Determining instrument errors	50	F	Fixed keys	13
	Determining the line-of-sight error (c)	52		Focus	15
	Determining V-index	53		Foot screws	10
	Diagonal eyepiece GFZ1	86		Function keys	13
	Dimensions	88	G	GEB111	22
	Display	10, 88		GEB121	22
	Display contrast	40	H	Hazards of use	63
	Display heater	41, 48		Hints for positioning	30
	Display resolution	87		Horizontal angle	11
	Displayed data	32		Horizontal circle	11
	Distance	46		Horizontal drive	10
	Distance measurement	33, 84, 90, 91		Horizontal plane	37
E	Economy mode	41		Hz collimation	45, 47
	EDM change (TCR only)	35		Hz-angle direction	47
	EDM measuring program	90, 91		Hz-Collim.	49
	EDM mode	42			
	EDM settings	42			
	EDM type	16			
	Electromagnetic compatibility (EMC)	76			
	Eyepiece	10			
	Eyepiece for steep angles	86			

Index, continued

- | | | | | | |
|----------|----------------------------------|------------|----------|--------------------------------|------------|
| I | Important components | 10 | L | Laser classification | 69 |
| | Infrared laser | 69 | | Laser intensity | 30 |
| | Input fields | 19 | | Laser plummet | 56, 73, 87 |
| | Inserting battery | 25 | | Laserpointer | 42 |
| | Inspection | 58 | | Laserpointer (TCR only) | 35 |
| | Instrument temperature | 47 | | Leica round prism GPR111 | 86 |
| | Integrated EDM | 69, 71 | | Level sensitivity | 87 |
| | Intended use of instrument | 60 | | Limits of use | 61 |
| | IR- Standard | 35 | | Line of sight | 11 |
| | IR-Standard | 43, 90, 91 | | Line-of-sight error | 49 |
| | IR-Tape | 35, 43, 90 | M | Measuring | 32 |
| | IR-Track | 35, 43, 90 | | Measuring preparation | 21 |
| | IR: infrared | 90 | | Menu | 38 |
| K | Key combinations | 14 | | Menu tree | 17 |
| | Keyboard | 13, 88 | | Messages | 83 |
| | Keypad | 10 | | Miniprism | 90 |
| | | | | Miniprism GMP111 | 43 |
| | | | N | Number of measurements | 89 |

Index, continued

- O** Objective 10
ON/OFF keys 13
Operating concept 13
Optical sight 10
Orientation of the V-angle 37
- P** Plumb line 12
Pointing 33
Power supply 89
Prism constant 44
Prism type 43
- R** Range 90, 91
Reflective target 43
Reflector height 19
Reflectorless EDM 57
Replacing battery 25
Resolution 45
Responsibilities 62
Reticle 12
Reticle illumination 41
- RL-Standard 42, 91
RL-Track 35, 42, 90, 91
RL: reflectorless 91
Round prism 90
Round prism GPR111 43
- S** Safety directions 60
Sector beep 39
Set Hz-angle 36
Set Hz-angle direction 36
Set Hz-angle to 0°00'00" 36
Setting up the Tripod 27
Settings 38
Shift 16
Slope % 37
Software versions 48
Standing axis 11
Standing axis inclination 12
Storage 80, 81
Symbols 16
System information 46
System settings 39

Index, continued

T	Tape	90	V	V-angle setting	37
	Technical data	87		V-Index	50
	Technical terms	11		Vertical angle	11
	Telescope	87		Vertical circle	11
	Telescope focusing ring	10		Vertical drive	10
	Temperature range	89		Vertical index error	50
	Tilt correction	44, 47		Visible laser	71
	Tilting axis	11	W	Warnings	83
	Tilting axis height	88		Weight	89
	Time per measurement	90, 91	Z	Zenith	12, 37
	Tracking mode	33		Zenith angle	11
	Transport	80			
	Tribrach removable	88			
	Tribrach shiftable	88			
	Tripod	55			
	Type of tribrach	88			
U	Unit settings	45			
	Unpacking	21			
	User entries	19			

Leica Geosystems AG, Heerbrugg, Switzerland, has been certified as being equipped with a quality system which meets the International Standards of Quality Management and Quality Systems (ISO standard 9001) and Environmental Management Systems (ISO standard 14001).



***Total Quality Management-
Our commitment to total customer
satisfaction***

*Ask your local Leica Geosystems
agent for more information about
our TQM program*

722277-1.0.0en

Printed in Switzerland - Copyright Leica
Geosystems AG, Heerbrugg,
Switzerland 2000
Translation of original text (722276-1.0.0de)



Leica Geosystems AG
CH-9435 Heerbrugg
(Switzerland)
Phone +41 71 727 31 31
Fax +41 71 727 46 73
www.leica-geosystems.com