

Leica iCON build

Custom-built solutions for Building Construction

Leica Geosystems – when it has to be right

With more than 200 years of history, Leica Geosystems, part of Hexagon, is the trusted supplier of premium sensors, software and services. Delivering value every day to professionals in surveying, construction, infrastructure, mining, mapping and other geospatial content-dependent industries, Leica Geosystems leads the industry with innovative solutions to empower our autonomous future.

Hexagon (Nasdaq Stockholm: HEXA B) has approximately 24,500 employees in 50 countries and net sales of approximately 5.4bn EUR. Learn more at hexagon.com and follow us @HexagonAB.



Copyright Leica Geosystems AG, 9435 Heerbrugg, Switzerland. All rights reserved. Printed in Switzerland – 2024. Leica Geosystems AG is part of Hexagon AB. 793504en – 09.24



Leica iCON build
Layout Object Flyer



Leica iCON
iCR70/805/80
Data sheet

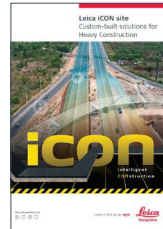

Leica iCON site
Brochure

Optimised for the building construction industry, Leica iCON build is specifically designed to streamline digital layout, as-built updates and verification tasks, making it suitable for a diverse array of construction trades.



Job site preparation



Foundations

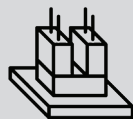

Structures

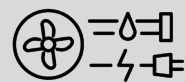

MEP and HVAC



Exteriors and facades



Leica Geosystems AG
Heinrich-Wild-Strasse
9435 Heerbrugg, Switzerland
+41 71 727 31 31

- when it has to be **right**



leica-geosystems.com



- when it has to be **right**



Leica Geosystems intelligent CONstruction

Enhancing your performance

Leica iCON build construction software provides you with unseen versatility and flexibility for modern building construction digital workflows. By fully understanding construction it enables you to be more efficient by improving speed, performance and accuracy when you carry out all positioning related tasks with just one construction tailored software solution.



Custom built for Building Construction

Leica iCON build is specifically designed for construction. Construction professionals can complete layout, as-built and verification tasks easily with speed and accuracy, leading to more efficiency and less rework on site.

- Innovative
- Smart workflows
- Easy to use

Complete Construction Portfolio

Leica iCON build is the core central interface to the complete range of iCON sensors enabling construction companies and field crews to learn its functionality once and be able to choose the right tool for their projects.

- Less training
- Reduced downtime
- Flexibility for projects

Digital Construction made easy

With a wide range of data support in Leica iCON build, field crews can benefit from modern digital construction workflows, helping to complete projects on time and under budget.

- Fast
- Accurate
- Exceptional layout functionality

Leica Geosystems

Your trusted partner

A site only works if all parties involved can expect professionalism in the execution of the individuals' tasks – resulting in strong partnerships. To ensure that Leica Geosystems fulfils highest expectations and is chosen as your partner, we continually focus on six areas.

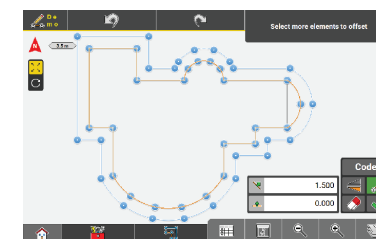

Innovation

- Ensures the most exciting and best user interface tailored to your needs
- Ensures keeping things simple for our users which require innovative solutions
- Ensures we listen to you and understand your construction applications



Versatility

- Through iCON build software that extends to grow your business
- Through exploring related segments by adding individual apps
- Through interchanging equipment between GPS & robotic total stations

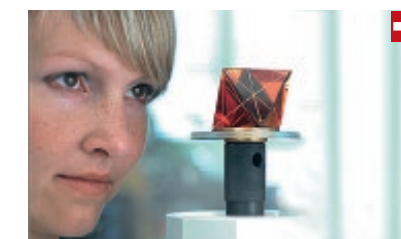

Quality

- In listening to your needs
- In the expertise of our sales & support teams
- In manufacturing and all development processes



Partnership

- By using Leica ConX remote support and data synchronisation
- By access to dedicated teams for consultation, support, webinars and frequent training.
- By listening to your ideas, recommendations and problems



Reliability

- Of commitments made
- In meeting technical specification of our products
- In our products in the field



Trust

- Our professional advice, be sure to work with the best adapted solution
- Our built-in checks, iCON build will keep you within project tolerances
- Our future software improvements that deliver attractive Customer Care Packages (CCPs)

Construction Cloud Connectivity



Ensure data integrity:

- Connect to industry leading construction cloud services
- Always work with the most reliable and up-to-date design data.
- Record as-built, verified data and report back to the office for progress tracking and quick decision making.



Do more with Leica ConX

- Remotely & online support your field crews
- Monitor operations remotely by assigning work and providing positioning & reference data
- Share updates and corrections to reference model data in real-time across the project.



iCON prep

Data preparation and as-built checking

- Prepare your field project in the office using the common iCON user interface
- Verify design data before releasing to field crews
- Check as-built data and compute distances, angles, area and volume
- Share project and jobs via cloud connections and ConX

Leica iCON build Profit from your investment



Philippe Richard, Productivity and Ergonomy R&D Director at Bouygues, France

Project: Grand Equipment Documentary Facility (GED Project), Paris
Application: Digital Layout and documentation aligned to BIM processes

"Thanks to this new solution, our layout specialists can layout faster and therefore have more time to ask questions and be more confident about what they are doing. This has helped to increase the efficiency within the team as they can complete their tasks quicker and with less stress," explains Richard. "By introducing BIM processes onto Bouygues' construction sites and training our employees on digital construction layout techniques, we were able to layout 3-4 times faster as well as to increase accuracy."



Mark Paterson, Site Manager, Hanham & Philp Contractors, New Zealand

Project: New Builds and Refurbishment for Commercial Construction
Application: Digital Layout, dilapidation and verticality checks

"We've fully embraced the no-strings approach! Once we saw it in action, we just couldn't believe how much more efficient it would make setting out, dilapidation and verticality checks". Hanham & Philp Contractors will benefit greatly from the improved speed and accuracy of the Leica iCON iCR70. Combined with the simple and easy to use software, this solution is a true game changer in the vertical construction industry."



Mike Sharp, CEO at Mike Sharp & Son, United Kingdom

Project: Construction of luxury residential single and multi-family properties
Application: Digital layout and as-built verification

"When we realised that we lose lots of time in the layout process, we started to look for modern alternatives that help us facilitate the whole layout process. One of the reasons why we choose the Leica iCON solution is the ease-of-use of both, instrument and software. The intuitive software interface makes it simple to operate, even for employees without a professional layout background".

High quality, lowest cost of ownership

Leica iCON with its high quality manufacturing and a range of Customer Care Products, ensures significantly reduced downtime. Periodic preventative maintenance will maximise productivity through training and innovative software improvements. Leica iCON offers the lowest cost of ownership and highest residual value.

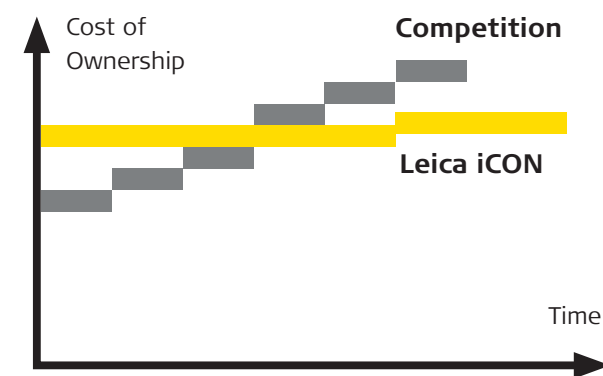

The iCON build product portfolio enables you to select your individual solution.

Invest in the solution you need today and have the flexibility to expand your product portfolio based on your future needs tomorrow.

Leica iCON iCT30 Layout Tool

Easy-to-use and durable layout tool for one person operation.

Leica iCON iCR70

Mid-range robotic total station with one-button operation.

Leica AP20 AutoPole

Enhancing construction workflows while minimising errors and rework.

Leica iCON iCR80/80s

High-end robotic total station with superior prism aiming, lock and re-lock technology.



Leica iCON iCB50/70

Intuitive, powerful and scalable series of total stations for routine construction tasks on site.

Leica iCON build field software

Core central interface to all iCON sensors and devices with unmatched simplicity but no compromises on functionality.

Leica iCON CC170/180/200

Robust, lightweight tablet PC with multi-touchscreen and versatile communication capabilities.

Leica iCON Prep

Easy data computation and preparation tool with the same user interface as the iCON field software.

Leica ConX and HxGN GeoCloud

Cloud-based collaboration tools allows you to manage, monitor and share in real-time your connected construction projects, including third party platforms.

Leica iCON build Straightforward software design

Learn how to gain productivity with iCON build

- One software solution: covers all your measurement tasks
- Complete construction portfolio: iCON build user interface works with all iCON total stations and GNSS.
- Speed up: get familiar with simple and intuitive software in minutes
- Focus on the job: let built-in intelligence guide you to results



Search Pilot Typical Wizard

- Do it right: colour coded warning system forces to keep tolerances

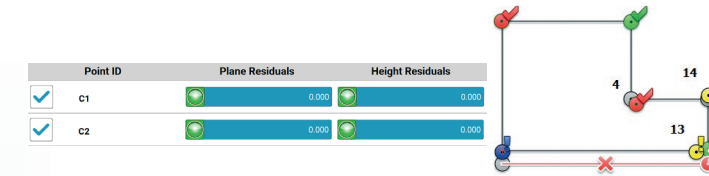

- More performance: add individual apps any time

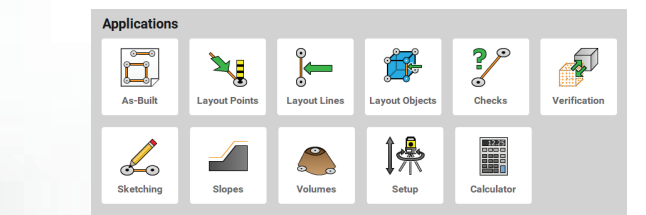

Learn how to structure your data and create work packages

- Enable easy object driven layout with support of IFC design models
- Import DXF, DWG and DGN files with no need for prior conversion in the office
- Treat layers and files the same way with MapOPS+
- Reduce model content to relevant objects only with easy to use with Tree view, Limit box and isolate tools
- Stake Out list: create work packages for quickest layout process including Autostake for MEP & HVAC workflows.

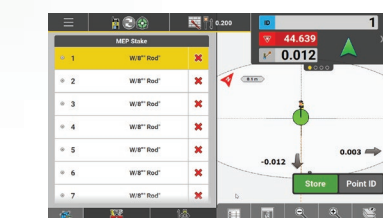

3D Orbiting

Let's you orbit your model in 3D and switch to 2D plans

Status Bar +

Clear status information PLUS shortcuts to most frequent tools

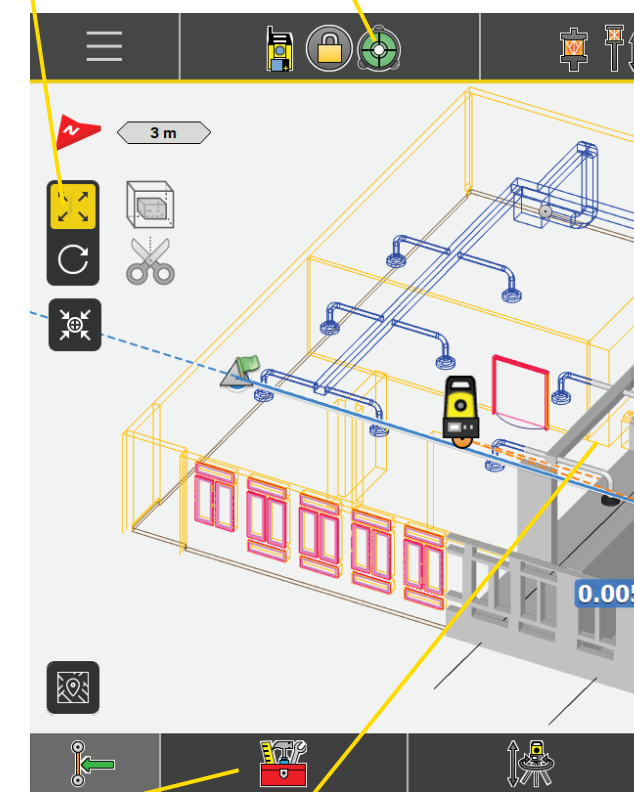

Tool Bar

Contains most relevant tools and functions tuned per application

IntuiNav +

Intuitive icons, traffic light colour codes and wizards for secure decision making. Straightened map via Split Screen and 3D graphics for clear data representation.

Measure Bar +

Configurable measure functions, visual and audio feedback, linked to controller hard key to trigger measurement, auto-switches to app specific task bar

Info Panel

Simple and configurable panels to give clear & immediate data and measure results including user guidance.

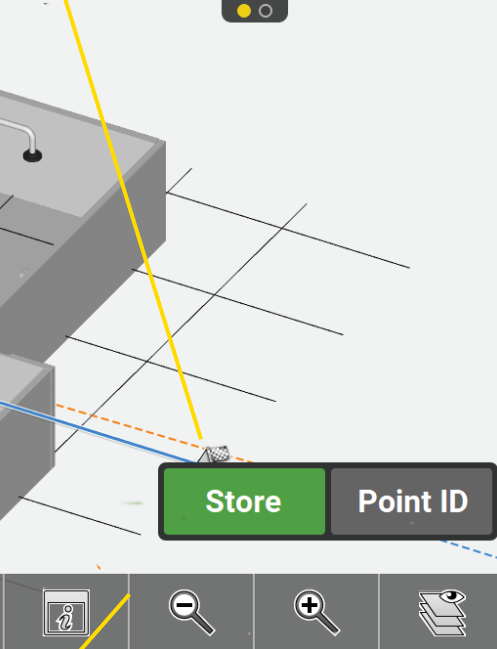
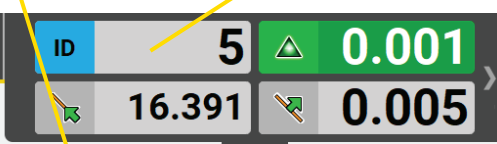

MapOPS +

Intelligent map controls including Smart Zoom & Auto-Pan. Manage data and graphical contents of map with Point List, File & Layer controls and clever viewing options.

Leica iCON build

The complete solution for all positioning and measuring tasks on site

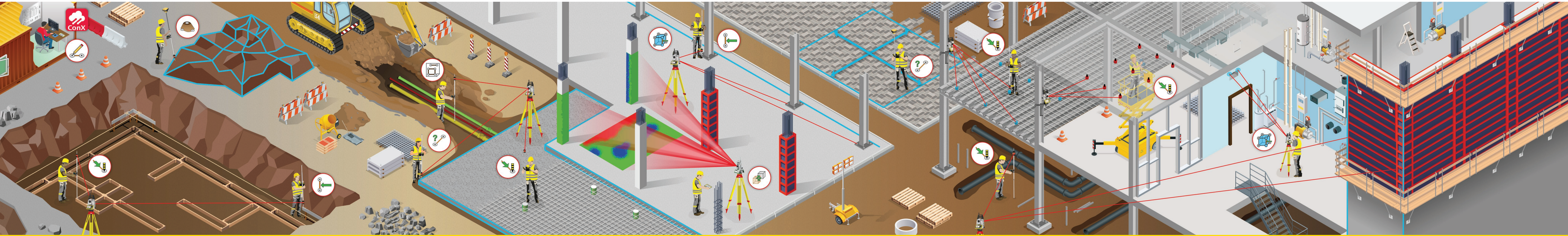

Leica iCON. Understanding construction.

Leica iCON build provides unmatched versatility and flexibility.

It enables you to carry out all positioning related tasks with just one solution. In addition, each iCON build application offers unique features and benefits, performance and accuracy.

Customize and extend your iCON field toolbox.



"EXTEND YOUR BUSINESS TO EARTHWORKS" iCON build is part of the unique iCON field toolbox, providing you with one solution for all your construction tasks across the entire job site. iCON field offers you the possibility to extend and customize applications according to your needs.

www.leica-geosystems.com/icon

Sketching



Applications

- Point Pilot for fast and intuitive input of plan dimensions
- Create points, arcs, lines, anchor bolts, patterns etc. within seconds
- Create centre points, mid points and intersections points from design data quickly and easily

Benefits

- Easily replicate digital blueprints
- Fix incomplete data in the field by adding missing structures
- Immediate response to changes on site
- Update plans to reflect true situations

Layout Lines

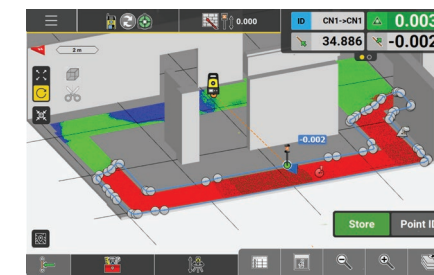

Applications

- Layout control lines, parallels, perpendiculars or arcs and align structures in relation to them
- Apply horizontal and vertical offsets
- Stake out strings to mark elevation for curb reference

Benefits

- Aligning columns and anchor bolt patterns easy and fast
- Simply rebuild and extend incomplete structures
- Monitor offset value to speed up form work erection
- Repeatable positioning of profile boards and precise transfer of alignments eliminating risk of board damage

Volumes

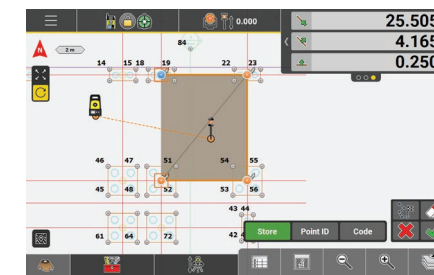

Applications

- Calculate volume of a stockpile or pit, comparison between surfaces or to the elevation
- Apply compaction factor in relation to your material
- Read out balanced site elevation

Benefits

- Accurate and flexible volume calculations, independent of size or shape
- Calculation of truck loading considering compaction factors
- Balance out Cut & Fill for optimised material and machine usage
- Monitor ongoing progress of earthworks

Verification



Applications

- Simple use of points and scans to verify against design at the right stage of the project.
- Easy selection of reference for real-time infield comparison
- Optimised heatmap to highlight points out of tolerance easily on site with reporting capabilities.

Benefits

- Highlight high and low spots for concrete pours to enable quick corrective measures
- Verify on site correct placement of walls, slabs, columns, pipes etc
- Quick in field decision making based on facts during construction.
- Direct export and reporting of verified data for project progress tracking and archiving

Checks

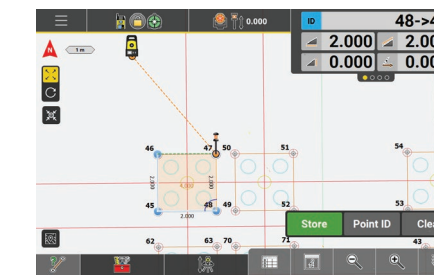

Applications

- Check distances (horizontal, vertical, sloped)
- Check grades and angles
- Check area and perimeter in 2D and 3D
- Info panel shows all results at a glance supported with graphics in map

Benefits

- Verify on site correct placement of walls, formwork, columns, pipes, etc.
- Decide in the field based on facts rather estimates
- Precise input for pre-fabrication of manholes, ventilation systems, windows or orders of sand, pavement, etc.

Points & MEP Layout

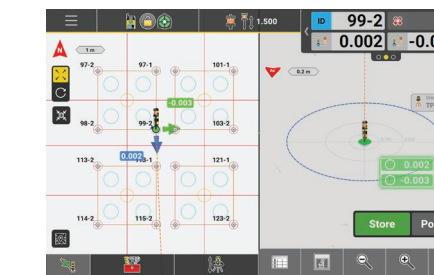

Applications

- Simply lay out sketched or imported points directly from the map
- Intuitively navigate to selected hanger, slit, insert, conduit, outlet, etc.
- Auto-select next point from list or the nearest from current location

Benefits

- Optimised in/out, left/right display via split screen and viewing options
- Colour code clearly indicates quality of laid out points
- Integrated tolerance checks increase precision and reduce errors Important point info available as code in info panel, e.g. "3/4" insert"

As-Built

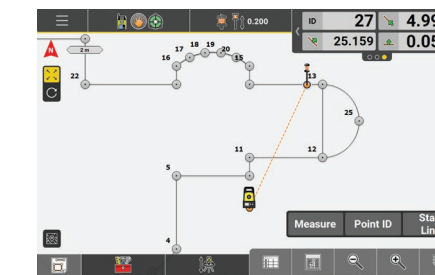

Applications

- Capture points, lines or arcs in one step with immediate graphical representation
- Apply codes per point and store measurements automatically
- Unique Start/Stop line feature accelerates line creation

Benefits

- Reduce site visits by visually verifying the measurements in the field
- Assign as-built data to individual layers while collecting points
- Back-up your control lines
- Store accurate 3D data as base for any CAD/BIM office operation or architectural planning